Statnett **Tennet**
Taking power further **SVENSKA
KRAFTNÄT****PSE** **50hertz****ENERGINET**

Explanatory document to the proposal for the common coordinated capacity calculation methodology for Capacity Calculation Region Hansa in accordance with Article 20(2) of the Commission Regulation (EU) 2015/1222 of 24 July 2015 establishing a Guideline on Capacity Allocation and Congestion Management

19th of February 2021

Abbreviations:

AAC	Already Allocated and nominated Capacity
AC	Alternating Current
AHC	Advanced Hybrid Coupling
ATC	Available Transfer Capacity
CA	Capacity Allocation
CACM	Capacity Allocation and Congestion Management
CC	Capacity Calculation
CCM	Capacity Calculation Methodology
CCR	Capacity Calculation Region
CGM	Common Grid Model
CNE	Critical Network Element
CNEC	Critical Network Element Contingency
CNTC	Coordinated Net Transmission Capacity
DA	Day Ahead
DC	Direct Current
FB	Flow-Based
GSK	Generation Shift Key
ID	Intraday
IGM	Individual Grid Model
NEMO	Nominated Electricity Market Operator
NTC	Net Transfer Capacity
NP	Net Position
OWF	Offshore Wind Farm
PTDF	Power Transfer Distribution Factor
RA	Remedial Action
TRM	Transmission Reliability Margin
TSO	Transmission System Operator
TTC	Total Transfer Capacity
XBID	Single intraday market coupling

Table of Contents

1. INTRODUCTION	5
2. LEGAL REQUIREMENTS.....	6
3. DEFINITION OF BIDDING-ZONE BORDERS IN CCR HANSA.....	9
3.1 DESCRIPTION OF THE DENMARK 1 – GERMANY/LUXEMBOURG AC BORDER	10
3.2 DESCRIPTION OF KRIEGERS FLAK COMBINED GRID SOLUTION.....	11
4. CAPACITY CALCULATION METHODOLOGY FOR THE DAY-AHEAD TIME FRAME	14
4.1 RULES FOR CALCULATING CROSS-ZONAL CAPACITY	14
4.2 DESCRIPTION OF THE CAPACITY CALCULATION METHODOLOGY IN CCR HANSA.....	14
4.2.1 MATHEMATICAL DESCRIPTION OF THE APPLIED APPROACH	16
4.2.2 CAPACITY LIMITATIONS ORIGINATING FROM THE AC GRID HANDLED BY AHC IN CCR NORDIC.....	20
4.2.3 CAPACITY LIMITATIONS ORIGINATING FROM THE AC GRID HANDLED BY AHC IN CCR CORE	20
4.2.4 FURTHER REQUIREMENTS FROM ARTICLE 21(1)(B) OF THE CACM REGULATION	21
4.3 METHODOLOGY FOR DETERMINING THE TRANSMISSION RELIABILITY MARGIN.....	22
4.4 METHODOLOGIES FOR DETERMINING OPERATIONAL SECURITY LIMITS, CONTINGENCIES RELEVANT TO CAPACITY CALCULATION AND ALLOCATION CONSTRAINTS	24
4.5 METHODOLOGY FOR DETERMINING THE GENERATION SHIFT KEYS	25
4.6 METHODOLOGY FOR DETERMINING REMEDIAL ACTIONS TO BE CONSIDERED IN CAPACITY CALCULATION	26
4.6.1 REMEDIAL ACTIONS TO MAINTAIN ANTICIPATED MARKET OUTCOME ON KF CGS.....	27
4.7 RULES FOR TAKING INTO ACCOUNT PREVIOUSLY ALLOCATED CROSS-ZONAL CAPACITY IN THE DAY-AHEAD TIME FRAME	27
4.8 FALLBACK PROCEDURE FOR DAY-AHEAD CAPACITY CALCULATION	27
5. CAPACITY CALCULATION METHODOLOGY FOR THE INTRADAY TIME FRAME.....	29
5.1 DESCRIPTION OF THE CAPACITY CALCULATION METHODOLOGY IN CCR HANSA.....	29
5.1.1 MATHEMATICAL DESCRIPTION OF THE APPLIED APPROACH	29
5.1.2 CAPACITY LIMITATIONS ORIGINATING FROM ADJACENT AC GRID	29
5.1.3 FURTHER REQUIREMENTS FROM ARTICLE 21(1)(B) OF THE CACM REGULATION	29
5.2 METHODOLOGY FOR DETERMINING THE TRANSMISSION RELIABILITY MARGIN.....	30
5.3 METHODOLOGIES FOR DETERMINING OPERATIONAL SECURITY LIMITS, CONTINGENCIES RELEVANT TO CAPACITY CALCULATION AND ALLOCATION CONSTRAINTS	30
5.4 METHODOLOGY FOR DETERMINING THE GENERATION SHIFT KEYS	30
5.5 METHODOLOGY FOR DETERMINING REMEDIAL ACTIONS TO BE CONSIDERED IN CAPACITY CALCULATION	30
5.6 RULES FOR TAKING INTO ACCOUNT PREVIOUSLY ALLOCATED CROSS-ZONAL CAPACITY IN THE INTRADAY TIME FRAME	30
5.7 INTRADAY REASSESSMENT FREQUENCY	30
5.8 FALLBACK PROCEDURE FOR INTRADAY CAPACITY CALCULATION	31
6. METHODOLOGY FOR THE VALIDATION OF THE CROSS-ZONAL CAPACITY FOR BOTH DAY-AHEAD AND INTRADAY ACCORDING TO ARTICLE 26.....	32
7. EVALUATION OF THE CCM IN LIGHT OF THE OBJECTIVES OF THE CACM REGULATION	34

<u>8. TIMESCALES FOR IMPLEMENTATION</u>	<u>35</u>
<u>9. RESULTS FROM CONSULTATION</u>	<u>37</u>
<u>ANNEX 1: JUSTIFICATION OF USAGE AND METHODOLOGY FOR CALCULATION OF ALLOCATION CONSTRAINTS IN PSE.....</u>	<u>40</u>
<u>ANNEX 2: ADVANCED HYBRID COUPLING (AHC) – A SHORT EXPLANATION.....</u>	<u>45</u>

1. Introduction

This document contains explanations for the proposal for a common coordinated capacity calculation methodology for the day-ahead and intraday time frame for the capacity calculation region of Hansa (CCR Hansa) in accordance with Article 20(2) of the Commission Regulation (EU) 2015/1222 of 24 July 2015¹ establishing a guideline on capacity allocation and congestion management (CACM Regulation). CCR Hansa Transmission system operators (TSOs) are obliged to consult stakeholders on proposals for terms and conditions or methodologies required by the CACM Regulation.

The CCR Hansa covers three bidding-zone borders and is placed between two larger CCRs: CCR Nordic and CCR Core. This document has been written with the aim of ensuring that the methodology developed in the CCR Hansa is as efficient as possible from a market point of view and that it is easily implementable from an operational and security of supply point of view when coordinating with adjacent regions. Moreover, the methodology proposed is aimed at being sustainable for future changes in CCR configurations.

The CCR Hansa proposes a capacity calculation methodology based on a coordinated NTC methodology with a strong link to the adjacent CCRs that have chosen flow-based capacity calculation methodologies. By utilising the flow-based capacity calculation methodologies of CCR Nordic and CCR Core in representing the AC meshed grids and using Advanced Hybrid Coupling for representing the CCR Hansa bidding-zone borders in the flow-based methodologies, the capacity calculation on the CCR Hansa borders is optimised to the fullest extent possible. This implicitly means that CCR Hansa assumes that, if possible, all AC grid limitations outside the CCR Hansa interconnectors are taken into account in the capacity calculations within CCR Nordic and CCR Core. The combination of the capacity calculation inputs from the adjacent CCR Nordic and CCR Core flow-based methodologies together with the capacity calculation results within CCR Hansa determine the cross-zonal capacity between the CCR Hansa bidding-zone borders, which shall be respected during the allocation process.

This document is structured as follows: Chapter 2 contains a description of the relevant legal references. Thereafter, Chapter 3 defines CCR Hansa and the borders that are subject to this proposal. Chapter 4 and 5 contain the explanation for the capacity calculation methodology for the day-ahead and intraday time frames presented in the legal proposal. The methodologies are described according to the requirements set in the CACM Regulation. A description of the proposed validation methodology is given in Chapter 6, while Chapter 7 contains an evaluation of the proposal against the objectives of the CACM Regulation. A planning for the implementation of this can subsequently be found in Chapter 8. Public consultation responses are shown and commented on in Chapter 9.

¹ Commission Regulation (EU) 2015/1222 of 24 July 2015 establishing a guideline on capacity allocation and congestion management, OJ 25-7-2015, L 197/24.

2. Legal requirements

According to Article 20(2) of the CACM Regulation, each CCR is required to submit a common capacity calculation methodology for approval by the relevant national regulatory authority (NRA) for each capacity calculation time frame. This is to be done no later than 10 months after approval of the CCRs for the day-ahead and intraday time frame.

According to the CACM Regulation, the approach to be used in the capacity calculation methodology (CCM) for both the day-ahead and intraday time frame is the flow-based approach.² However, according to Article 20(7) of the CACM Regulation, CCR Hansa TSOs may jointly request the NRAs to apply the coordinated net transmission capacity approach (CNTC) in regions and on bidding-zone borders if the CCR Hansa TSOs are able to demonstrate that the application of the CCM using the flow-based approach would not yet be more efficient compared to the CNTC approach and assuming the same level of operational security in the concerned region.

In regards to the application of the flow-based approach, the preamble of the CACM Regulation, in point (7), states the following:

“The flow-based approach should be used as a primary approach for day-ahead and intraday capacity calculation where cross-zonal capacity between bidding zones is highly interdependent. The flow-based approach should only be introduced after market participants have been consulted and given sufficient preparation time to allow for a smooth transition. The coordinated net transmission capacity approach should only be applied in regions where cross-zonal capacity is less interdependent and it can be shown that the flow-based approach would not bring added value.”

First, a number of relevant definitions from the CACM Regulation are stated below.

*“‘coordinated net transmission capacity approach’ means the capacity calculation method based on the principle of assessing and defining ex ante a maximum energy exchange between adjacent bidding zones”.*³

*“‘flow-based approach’ means a capacity calculation method in which energy exchanges between bidding zones are limited by power transfer distribution factors and available margins on critical network elements.”*⁴

*“‘reliability margin’ means the reduction of cross-zonal capacity to cover the uncertainties within capacity calculation.”*⁵

*“‘allocation constraints’ means the constraints to be respected during capacity allocation to maintain the transmission system within operational security limits and have not been translated into cross-zonal capacity or that are needed to increase the efficiency of capacity allocation;”*⁶

*“‘operational security limits’ means the acceptable operating boundaries for secure grid operation such as thermal limits, voltage limits, short-circuit current limits, frequency and dynamic stability limits;”*⁷

*“‘contingency’ means the identified and possible or already occurred fault of an element, including not only the transmission system elements, but also significant grid users and distribution network elements if relevant for the transmission system operational security;”*⁸

² Article 20(1) of CACM Regulation.

³ Article 2(8) of the CACM Regulation.

⁴ Article 2(9) of the CACM Regulation.

⁵ Article 2(14) of the CACM Regulation.

⁶ Article 2(6) of the CACM Regulation.

⁷ Article 2(7) of the CACM Regulation.

⁸ Article 2(10) of the CACM Regulation.

“‘coordinated capacity calculator’ means the entity or entities with the task of calculating transmission capacity, at regional level or above;”⁹

“‘generation shift key’ means a method of translating a net position change of a given bidding zone into estimated specific injection increases or decreases in the common grid model;”¹⁰

“‘remedial action’ means any measure applied by a TSO or several TSOs, manually or automatically, in order to maintain operational security.”¹¹

Secondly, in Article 21 the CACM Regulation sets further requirements for the proposal for a CCM.

“1. The proposal for a common capacity calculation methodology for a capacity calculation region determined in accordance with Article 20(2) shall include at least the following items for each capacity calculation time frame:

a) methodologies for the calculation of the inputs to capacity calculation, which shall include the following parameters:

- I. a methodology for determining the reliability margin in accordance with Article 22;*
- II. the methodologies for determining operational security limits, contingencies relevant to capacity calculation and allocation constraints that may be applied in accordance with Article 23;*
- III. the methodology for determining the generation shift keys in accordance with Article 24;*
- IV. the methodology for determining remedial actions to be considered in capacity calculation in accordance with Article 25.*

b) detailed description of the capacity calculation approach which shall include the following:

- I. a mathematical description of the applied capacity calculation approach with different capacity calculation inputs;*
- II. rules for avoiding undue discrimination between internal and cross-zonal exchanges to ensure compliance with point 1.7 of Annex I to Regulation (EC) No 714/2009;*
- III. rules for taking into account, where appropriate, previously allocated cross-zonal capacity;*
- IV. rules on the adjustment of power flows on critical network elements or of cross-zonal capacity due to remedial actions in accordance with Article 25;*
- V. for the flow-based approach, a mathematical description of the calculation of power transfer distribution factors and of the calculation of available margins on critical network elements;*
- VI. for the coordinated net transmission capacity approach, the rules for calculating cross-zonal capacity, including the rules for efficiently sharing the power flow capabilities of critical network elements among different bidding-zone borders;*
- VII. where the power flows on critical network elements are influenced by cross-zonal power exchanges in different capacity calculation regions, the rules for sharing the power flow capabilities of critical network elements among different capacity calculation regions in order to accommodate these flows.*

c) a methodology for the validation of cross-zonal capacity in accordance with Article 26.

⁹ Article 2(11) of the CACM Regulation.

¹⁰ Article 2(12) of the CACM Regulation.

¹¹ Article 2(13) of the CACM Regulation.

2. For the intraday capacity calculation time frame, the capacity calculation methodology shall also state the frequency at which capacity will be reassessed in accordance with Article 14(4), giving reasons for the chosen frequency.

3. The capacity calculation methodology shall include a fallback procedure for the case where the initial capacity calculation does not lead to any results.”

The methodologies to be included in the proposal are further described in Articles 22 to 26 of the CACM Regulation.

According to Article 21(4) of the CACM Regulation, all CCR Hansa TSOs shall, as far as possible, use harmonised capacity calculation inputs. Therefore, the common capacity calculation methodology for the CCR Hansa should include compatible tools and principles suitable to be processed by the coordinated capacity calculator (CCC) in order to calculate the cross-zonal capacity values.

As a general point, all methodologies and proposals developed under the CACM Regulation should align with the objectives of Article 3 of the CACM Regulation. More specifically, Article 9(9) of the CACM Regulation requires that:

“The proposal for terms and conditions or methodologies shall include a proposed timescale for their implementation and a description of their expected impact on the objectives of this Regulation.”

3. Definition of bidding-zone borders in CCR Hansa

This methodology relates to the bidding-zone borders of CCR Hansa. In line with Article 4 of ACER's decision¹² on the determination of capacity calculation regions, CCR Hansa currently consists of the following bidding-zone borders:

- 1) Denmark 1 - Germany/Luxembourg (DK1-DE/LU)
Energinet.dk and TenneT TSO GmbH;
Via onshore AC-grid connection
Additional information on the DK1-DE/LU border is given in section 3.1
- 2) Denmark 2 - Germany/Luxembourg (DK2-DE/LU)
Energinet.dk and 50Hertz Transmission GmbH; and
Via the Kontek HVDC interconnector
- 3) Sweden 4 - Poland (SE4 – PL)
Svenska Kraftnät and PSE S.A.
Via the SwePol HVDC interconnector

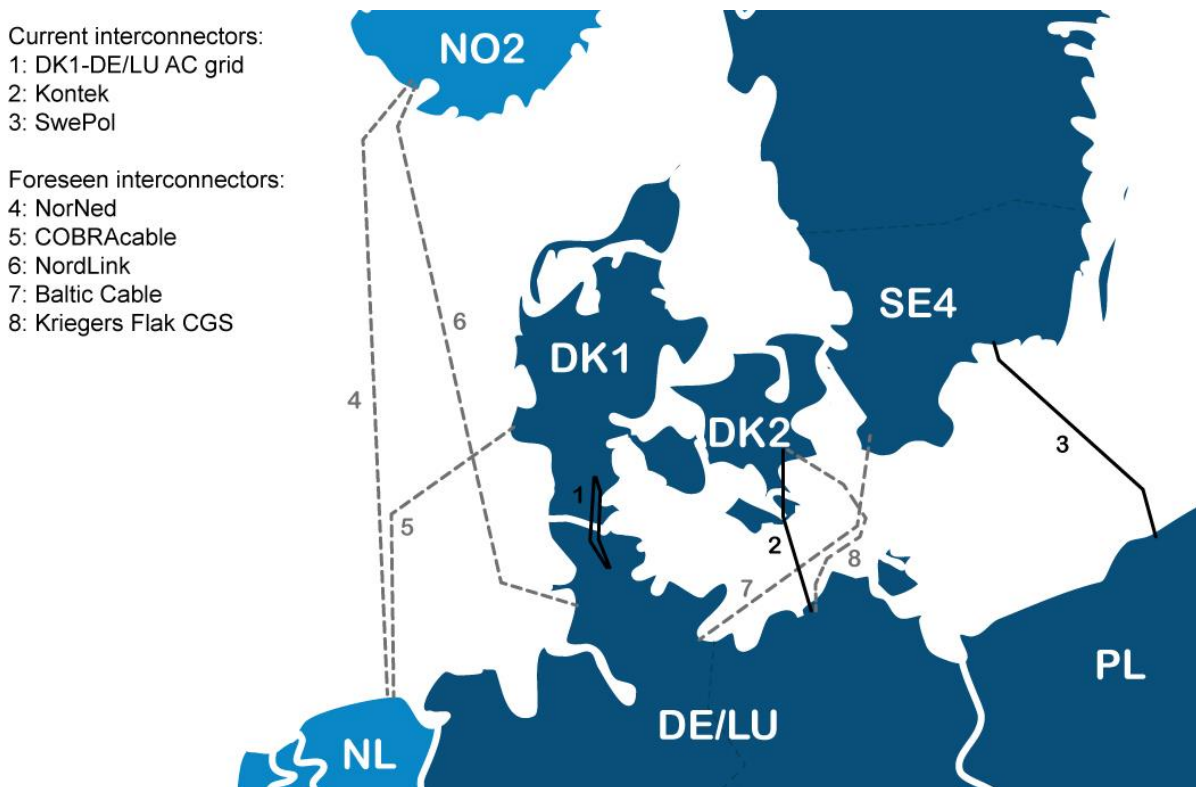

Figure 1: Geographical overview of the current and foreseen bidding-zone borders covered by CCR Hansa.

Additionally, new bidding-zone borders are expected to be added to the CCR Hansa through requests for amendment. In the upcoming years, it is foreseen that requests for amendment could be handed in for the following bidding-zone borders to be added to CCR Hansa:

- 4) Norway 2 – the Netherlands (NO2-NL)
Via the NorNed interconnector

¹² ACER decision 06-2016 of 17 November 2016.

Additionally, it is expected that NorNed (NO2-NL) will be added to CCR Hansa once Norway ratifies the CACM Regulation. The 3rd EU liberalisation package, EU Regulation No. 713-714/2009 was ratified in Norway in April 2018, but the Network Codes and Guidelines are not yet ratified.

- 5) Denmark 1 – the Netherlands (DK1-NL)
Via the COBRACable HVDC interconnector
Request for amendment to add the DK1-NL border to CCR Hansa was handed in to allNRAs for approval on 13 March 2018.
- 6) Germany/Luxembourg – Norway 2 (DE/LU-NO2)
Via the NordLink HVDC interconnector
Similar prerequisite as NorNed that Norway ratifies the CACM Regulation. Foreseen go-live of the IC is end of 2020.
- 7) Germany/Luxembourg – Sweden 4 (DE/LU-SE4)
Via the BalticCable HVDC interconnector
The owner of Baltic cable (SE4-DE/LU) is a certified TSO. When the Baltic Cable becomes officially assigned to CCR Hansa, which is expected in mid-2021, this will be considered in the scope of the CCR.

Lastly, an additional interconnector is to be added to an already existing bidding-zone border in CCR Hansa:

- 8) Denmark 2 – Germany/Luxembourg (DK2-DE/LU)
Through the development of Kriegers Flak Combined Grid Solution, a hybrid interconnector consisting of interconnected offshore wind farms in the DK2 and DE/LU bidding zone, an additional interconnector will arise parallel to the already existing Kontek interconnector.
Additional information on the Kriegers Flak CGS is given in section 3.2

As is apparent from the list and table above, CCR Hansa largely consists of fully controllable HVDC interconnectors. There are two exceptions to this, the AC-grid border DK1-DE/LU and the Kriegers Flak CGS attributed to the DK2-DE/LU border, of which an additional description will be given in the next sections.

3.1 Description of the Denmark 1 – Germany/Luxembourg AC border

CCR Hansa consists of two DC-connected borders and one AC-connected border. To understand the capacity calculation methodology and the related methodologies for remedial actions it is important to know the current topology of the AC border which is shown in Figure 2. When the 220kV lines (green lines in map) are upgraded to 400kV, the one which connects to the Danish substation “Ensted” will instead connect to “Kassø”, making the existing and new 400kV lines fully parallel.

At present, there are two phase-shifting transformers placed in Denmark at the substations where the 220kV lines connect. The aim of these is to equalize the distribution of flows between the 400kV and 220kV lines and therefore to ensure the 220kV lines are not overloaded in operation.

There is no synchronous connection from DK1 to DK2 or Scandinavia. DK1 is only connected with AC lines to the German grid. This means that all exchanges between DK1 and DE have to flow from Kassø to Audorf. Only the grid between Kassø and Audorf is represented within the capacity calculation of CCR Hansa. The 150kV line from Ensted in Denmark and Flensburg in Germany is only a supply line, as there is no transfer capability between the bidding zones of DK1 and DE on this line. Due to historic reasons, significant parts of Flensburg is supplied from Denmark and is part of the market in DK1.

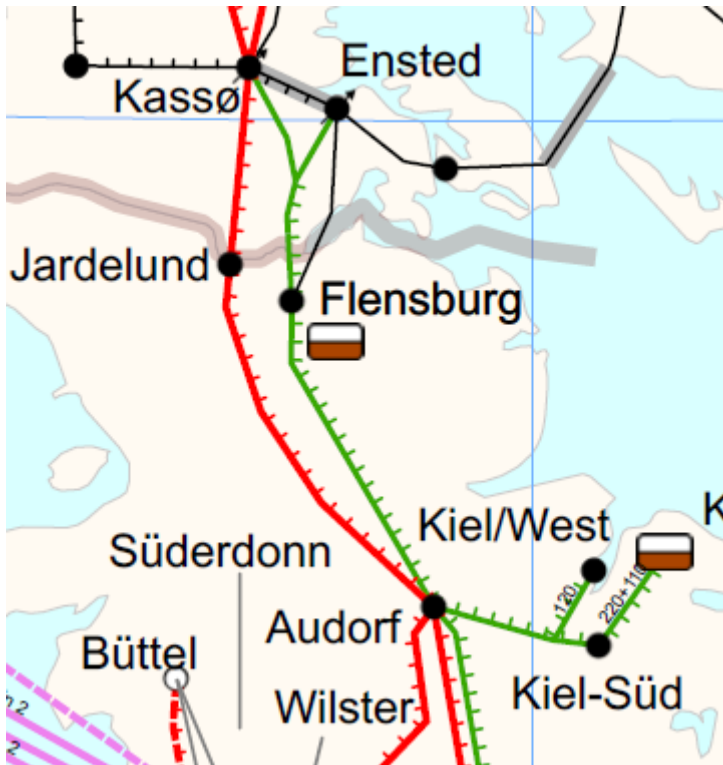

Figure 2: Topological overview of the Denmark West (DK1) – Germany (DE/LU) AC connection within CCR Hansa. The green lines are 220kV lines and the red lines are 400kV lines, and these are both double circuits across the border between Denmark (DK1) and Germany (DE/LU).

Since both cross-border connections are connected to the substations Kassø in Denmark and Audorf in Germany, the DK1-DE/LU border is considered radial and no loop flows can occur.

3.2 Description of Kriegers Flak Combined Grid Solution

From 2019, two separate connections will make up the DK2-DE bidding-zone border. The existing KONTEK DC interconnector and the Kriegers Flak Combined Grid Solution (KF CGS).

KF CGS is a novel type of CCR Hansa interconnector, being a hybrid with interconnector and offshore wind farm (OWF) grid connection.

Due to the fact that the transmission grids in Eastern Denmark and Germany, respectively, belong to different synchronous areas and thus are operated non-synchronously, KF CGS, in case it being solely an CCR Hansa interconnector between Eastern Denmark and Germany with no OWFs connected to it, would have been set up as an ordinary DC line. For both technical and economic reasons, KF CGS is set up as an AC line, however with a back-to-back converter which is located at one of its ends and converts AC into DC and back into AC and thus enables the connection of the Nordic synchronous area with the one in continental European synchronous areas.

KF CGS is comprised of

- a back-to-back converter station at the German terminal of KF CGS.
- two German OWFs that feed into the German bidding zone through an AC radial grid connection.
- an AC cable connecting the grid connection of the German OWFs with the grid connection of the Danish OWFs.
- one Danish OWF that feeds into the DK2 bidding zone through an AC radial grid connection

Despite its technical setup, KF CGS behaves in operational terms like an ordinary DC link and therefore is to be treated as such.

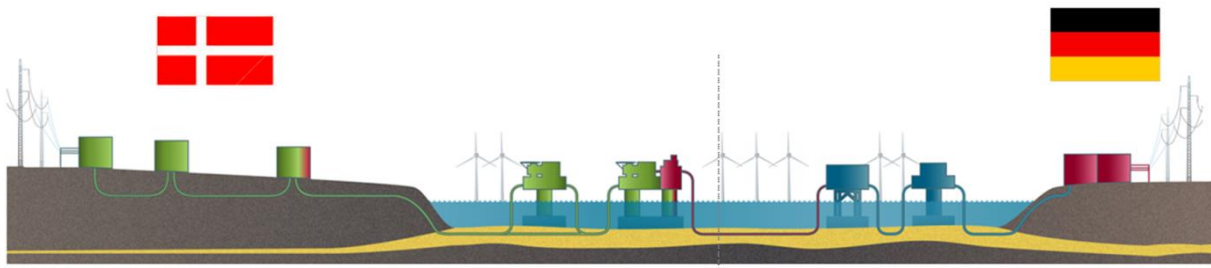

Figure 3 Conceptual sketch of KF CGS that is constituted of parts from a Danish OWF (with two offshore substations), two German OWFs, a connecting cable between the OWFs, and a back-to-back converter station. Green colours indicate parts of KF CGS stemming from the Danish OWF, blue colours show parts stemming from the German OWFs, and red colours show parts stemming from the CCR Hansa interconnector.

As such, KF CGS is not directly comparable to a traditional interconnector, regardless of it being a DC or an AC connection, but is instead a hybrid. When the capacity for the DK2-DE/LU bidding-zone border is calculated, the hybrid nature of KF CGS means that special considerations have to be made in the capacity calculation methodology.

The hybrid nature of KF CGS has two concrete implications for the possibility of transmitting energy between the DK2 and DE/LU bidding zones.

1. The expected generation of the German OWF(s) [of the Danish OWF(s)] reduces the import capacity of the German bidding zone [of the Danish bidding zone] over KF CGS.
2. The expected generation of the German OWF(s) [of the Danish OWF(s)] can in some cases increase the export capacity of the German bidding zone [of the Danish bidding zone] over KF CGS.

Regarding point 1, the capacity that can be given to the market depends on the expected generation of the OWFs since the KF CGS CCR Hansa interconnector can only utilise the share in the transmission capacity on KF CGS which is not needed to transmit the electricity generation of the German and Danish OWFs to the respective national transmission grid.

OWF generation has prioritised access to the transmission capacity towards its home market which directly reduces the capacity available for the electricity markets. This is reflected in the mathematical description of the capacity calculation methodology as a forecast term related to already allocated capacity.

Regarding point 2, the fact that generation units are physically located on the CCR Hansa interconnector implies that wind generation can supplement the flow on the CCR Hansa interconnector. In the case where the sending end terminal constitutes a binding constraint (a bottleneck) for the capacity calculation, wind generation at the sending OWF can compensate for the transmission loss between the constraint and the OWF to allow a higher market capacity. In the mathematical description of the capacity calculation methodology this is introduced as a KF CGS-specific forecast term related to the loss factor that is central to determining the TTC (Total Transfer Capacity). This is especially relevant for the northbound market capacity.

Conceptually, KF CGS consists of three sections, as shown in Figure 4, with section 1 being the radial grid connection of the Danish OWF to DK2 (capacity of 600 MW), section 2 being the cable connection between the Danish OWFs and the German OWFs (capacity of about 400 MW), and section 3 being the radial grid connection of the Germans OWFs to Germany (capacity of about 400 MW).

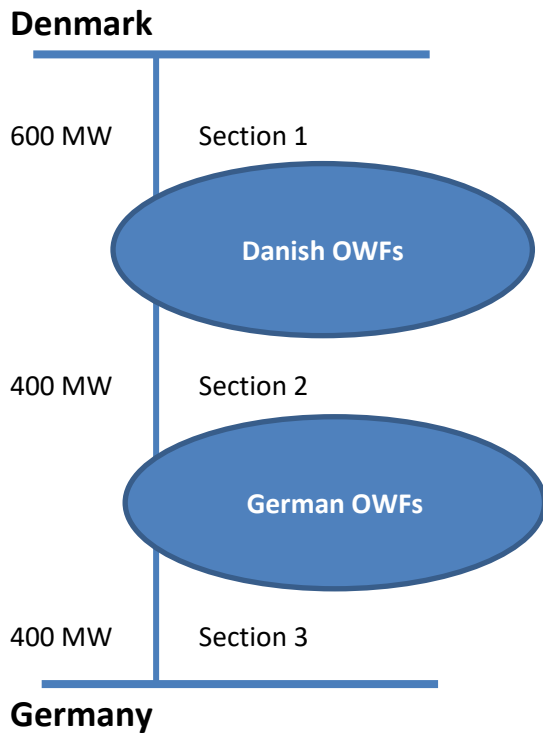

Figure 4 Conceptual illustration of transmission capacity of different sections of KF CGS

For the northbound capacity, transmission losses imply that section 3 is a bottleneck, such that the transmission capacity of about 400 MW can never be fully utilised with northbound flow.

Using the generation of the German OWFs located physically at the interface between section 2 and 3 partly, or if so, completely for covering the grid losses on section 3 moves the bottleneck from section 3 to section 2. This means that the market capacity can be increased by the equivalent of the full load grid losses of section 3.

For the southbound capacity, section 2 is the bottleneck from the outset, since the transmission capacity of section 1 is higher than that of section 2. Only in case of an outage on section 1 can this section make up a bottleneck, in which case expected generation on the Danish OWFs can increase the market capacity.

The KF CGS was granted a 10 year exception with the Commission Decision (EU) 2020/2123 of 11 November 2020 on the derogation for KF CGS following Article 64 of Regulation (EU) 2019/943. The decision sets that the capacity basis to be used for calculating the minimum capacity shall be the residual capacity after deduction of the capacity necessary for transporting the forecasted electricity production by the wind farms connected to the Kriegers Flak Combined Grid Facility at the day ahead stage to the respective national onshore systems, rather than the total transmission capacity. The Hansa CCM is reflecting this decision in the solutions described for KF CGS throughout the Hansa CCM.

4. Capacity calculation methodology for the day-ahead time frame

This chapter describes the target capacity calculation methodology which will be applied for CCR Hansa bidding-zone borders in the day-ahead time frame.

4.1 Rules for calculating cross-zonal capacity

Article 3 in the CCM for CCR Hansa describes the rules for calculating cross-zonal capacity in CCR Hansa and makes several references to the relevant articles in the CACM Regulation.

The capacity calculation approach for CCR Hansa follows the coordinated net transmission capacity (CNTC) approach. As written in CACM Regulation Article 20(7), CCR Hansa TSOs may jointly request the competent regulatory authorities to apply the CNTC approach, if the CCR Hansa TSOs are able to demonstrate that the application of the capacity calculation methodology using the flow-based approach would not yet be more efficient compared to the CNTC approach assuming the same level of operational security in the concerned region.

The CCR Hansa TSOs will provide the CCC with the following information listed in Article 3 of the CCM for each market time unit.

This information is necessary for the CCC to calculate the cross-border capacity in both directions for the CCR Hansa bidding-zone borders.

The rules also specify that if the capacity calculation cannot be performed by the CCC, then the fallback proposals will apply.

The rules also state that the CCC shall submit the results of the capacity calculation to the CCR Hansa TSOs for validation and, in the end, make sure that the validated cross-zonal capacities and allocation constraints are provided to the relevant NEMOs before the day-ahead and intraday firmness deadline following CACM Regulation Articles 69 and 58.

4.2 Description of the capacity calculation methodology in CCR Hansa

The capacity calculation methodology proposed for the day-ahead time frame unifies 3 congestion-relevant parts. It takes advantage of the flow-based methodologies with the AHC approach developed in CCR Nordic and CCR Core in order to represent the limitations in the AC grids, while the actual CCR Hansa interconnector capacities are addressed individually within CCR Hansa.

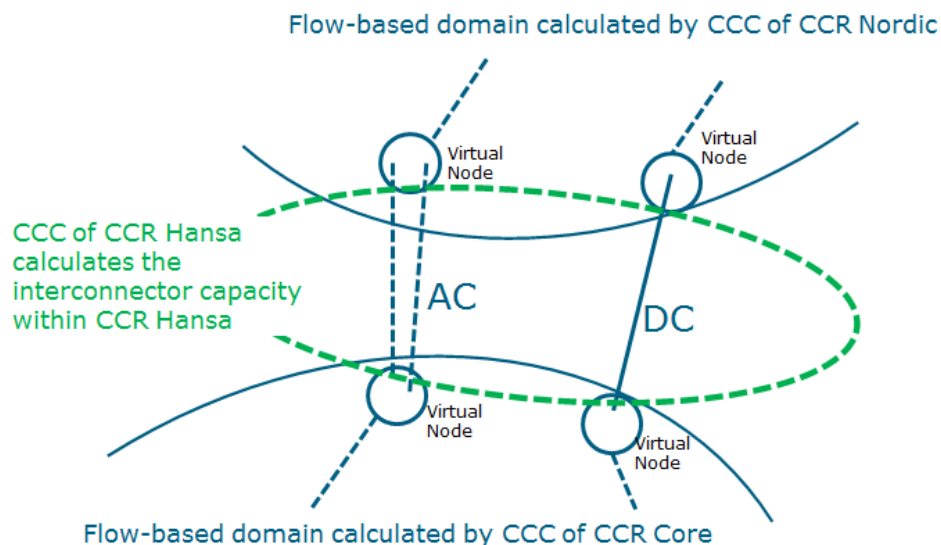

Figure 5: Capacity calculation in CCR CORE, CCR Nordic, and CCR Hansa

Cross-border trade between bidding zones always affects at least three different parts of the grid:

1. The AC grid sensitive to the trade surrounding the CCR Hansa interconnector on the exporting side;
2. The CCR Hansa interconnector itself;
3. The AC grid sensitive to the trade surrounding the CCR Hansa interconnector on the importing side.

This holds true for all cross-border trade, irrespective of the type of CCR Hansa interconnector (AC or DC) or the applied capacity calculation methodology (NTC or flow-based).

Years of experience with capacity calculation have shown that a congestion resulting from a cross-border trade can occur in each of these three parts of the grid. In order to maintain system security, it is therefore necessary to take all three parts into account in the capacity calculation.

Since CCR Hansa has the unique feature that all bidding zones are currently connected by means of radial lines, the assessment of cross-border capacity can be split into three separate parts. This allows the CCR Hansa TSOs to look at the impact of cross-border trade independently on each part of the grid.

The methodology is thus based on three parts, as depicted in Table 1.

1. The actual CCR Hansa interconnector capacity within the CCR Hansa;
2. The limitations on the CCR Hansa interconnectors from the AC grid handled by AHC in CCR Core;
3. The limitations on the CCR Hansa interconnectors from the AC grid handled by AHC in CCR Nordic.

These three contributions together deliver the limits on flow on the CCR Hansa interconnectors and can be represented as in Table 1. The flexibility the methodology allows for is to contain both flow-based restrictions as well as CNTC restrictions at the same time.



	Core AHC	Actual Interconnector Capacity	Nordic AHC
TSO1→TSO2		1400MW	
TSO2→TSO3		600MW	
TSO1→TSO4		1000MW	
	Part of Core CC	Part of Hansa CC	Part of Nordic CC

Table 1: An example of the capacity calculation in CCR Core, CCR Nordic and CCR Hansa

In a CNTC methodology, the following terminologies are used. The NTC is the maximum total exchange program between two adjacent bidding zones compatible with security standards, and taking into account the technical uncertainties on future network conditions: $NTC = TTC - TRM$. In case the TRM equals zero, the NTC equals the TTC. The ATC is a measure of the transfer capability remaining in the physical transmission network for further commercial activity over and above already committed uses: $ATC = NTC - AAC$. In case the AAC equals zero, the ATC equals the NTC.

The capacity calculation is done for each day-ahead and intraday market time unit, currently set at a one-hour resolution.

4.2.1 Mathematical description of the applied approach

The calculation of the actual CCR Hansa interconnector capacity, as shown in Figure 6, is based mainly on the physical properties of the cross-border lines and stations on each end. As CCR Hansa contains DC borders, AC borders and KF CGS, being a hybrid CCR Hansa interconnector and offshore wind farm (OWF) grid connection between Germany and Denmark, these have to be addressed separately in an ex-ante process. The following aspects should be taken into account when calculating the actual CCR Hansa interconnector capacity for the AC and the DC borders as well as KF CGS.

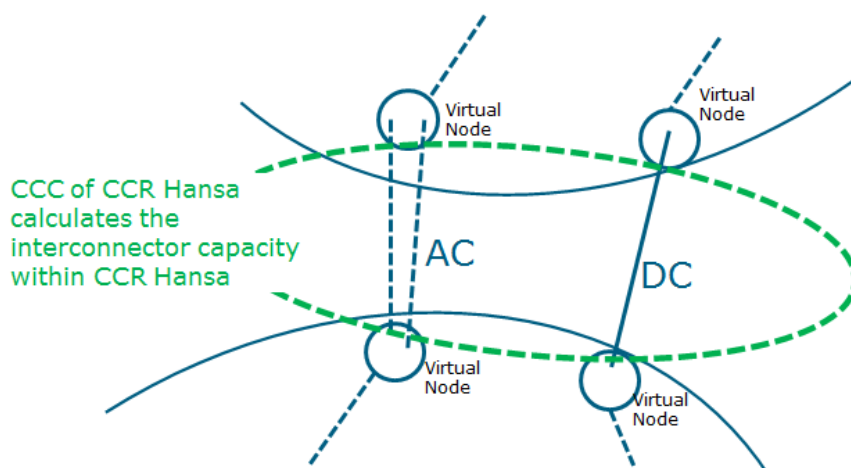

Figure 6: The actual CCR Hansa interconnector capacity which is the responsibility of CCR Hansa to determine

1. CCR Hansa TSOs calculate capacity on a bidding-zone border connected with DC lines or in case of KF CGS on a line per line basis, in the following named DC line i . On a bidding-zone border with AC connections, the transfer capacity on the whole bidding-zone border is computed, as it is not possible to control the division of flow between AC lines, in the case there are parallel lines across the border. The capacity shall be calculated for both directions, $A \rightarrow B$ and $B \rightarrow A$.

The $ATC_{i,DC,A \rightarrow B}$ on a DC line i in the direction $A \rightarrow B$ is calculated as follows:

$$ATC_{i,DC,A \rightarrow B} = TTC_{i,A \rightarrow B} - AAC_{i,A \rightarrow B} + AAC_{i,B \rightarrow A}$$

When the DC line is not in operation ($TTC = 0$) due to a planned or unplanned outage:

$$ATC_{i,DC,A \rightarrow B} = 0$$

Where

- A := Bidding zone A.
- B := Bidding zone B.
- $ATC_{i,DC,A \rightarrow B}$:= Available Transfer Capacity on a DC line i in direction $A \rightarrow B$ provided to the day-ahead market.
- $TTC_{i,A \rightarrow B}$:= Total Transfer Capacity (TTC) of a DC line i in direction $A \rightarrow B$. The TTC corresponds only to the full capacity of the DC line, in case of no failure on the CCR Hansa interconnector, including converter stations.

The TTC for a DC line i is defined as follows:

$$TTC_{i,A \rightarrow B} = \alpha_i \cdot P_{i,max\ thermal} * (1 - \beta_{i, Loss,A \rightarrow B})$$

$AAC_{i,A \rightarrow B}$:=	Already Allocated and nominated Capacity for a DC line i in direction $A \rightarrow B$ in accordance with Article 11.
$AAC_{i,B \rightarrow A}$:=	Already Allocated and nominated Capacity for a DC line i in direction $B \rightarrow A$ in accordance with Article 11.
α_i	:=	Availability factor of equipment defined through scheduled and unscheduled outages, α_i , being a real number in between and including 0 and 1.
$P_{i,max\ thermal}$:=	Thermal capacity for a DC line i .
$\beta_{i.Loss,A \rightarrow B}$:=	Loss factor in case of explicit grid loss handling on a DC line i in direction $A \rightarrow B$, can be a different value depending on α_i . In case of implicit loss handling, the loss factor is set to zero but taken into account as an allocation constraint in accordance with Article 8.

- The following mathematical description applies for the calculation of ATC on the AC lines between bidding zones. The capacity shall be calculated for both directions, $A \rightarrow B$ and $B \rightarrow A$.

The $ATC_{AC,A \rightarrow B}$ on a bidding-zone border that is connected by AC lines in the direction $A \rightarrow B$ is calculated as follows:

$$ATC_{AC,A \rightarrow B} = TTC_{A \rightarrow B} - TRM_{A \rightarrow B} - AAC_{A \rightarrow B} + AAC_{B \rightarrow A}$$

When the CCR Hansa AC interconnector is out of operation ($TTC = 0$) due to a planned or unplanned outage:

$$ATC_{AC,A \rightarrow B} = 0$$

Where

A	:=	Bidding zone A.
B	:=	Bidding zone B.
$ATC_{AC,A \rightarrow B}$:=	Available Transfer Capacity of a bidding-zone border in direction $A \rightarrow B$, provided to the day-ahead market.

$TTC_{A \rightarrow B}$:= Total Transfer Capacity of a bidding-zone border in direction $A \rightarrow B$.

The TTC is determined according to the following steps:

1. Performing load-flow calculation using the CGM and the GSKs according to Article 9
2. When assessing the loading of the individual circuits of the CCR Hansa Interconnector, and to take N-1 security criterion into account, the processes of points 3 and 4 are repeated with the outage of each of the individual circuits on the CCR Hansa Interconnector where the minimum TTC for each CCR Hansa Interconnector and in each direction is set as TTC in the given direction.
3. Using the GSK to increase the net position of bidding zone A while decreasing the net position of bidding zone B at equal amounts until a circuit or multiple circuits of the CCR Hansa Interconnector reach their permanent admissible thermal loading. The TTC is then equal to the maximum exchange between the bidding zones.
4. The process of point 3 is repeated in the opposite direction to determine the TTC in the direction B to A.

$TRM_{A \rightarrow B}$:= Transmission Reliability Margin for a bidding-zone border in direction $A \rightarrow B$, in accordance with Article 6.

$AAC_{A \rightarrow B}$:= Already Allocated and nominated Capacity for a bidding-zone border in direction $A \rightarrow B$, in accordance with Article 11.

$AAC_{B \rightarrow A}$:= Already Allocated and nominated Capacity for a bidding-zone border in direction $B \rightarrow A$, in accordance with Article 11.

3. The following mathematical description applies solely to the calculation of ATC on the Kriegers Flak Combined Grid Solution (KF CGS), being a hybrid interconnector and offshore wind farm (OWF) grid connection between DK2-DE/LU. This approach is compliant with the Commission Decision (EU) 2020/2123 of 11 November 2020 on the derogation for KF CGS following Article 64 of Regulation (EU) 2019/943.

The $ATC_{KF\ CGS, DE \rightarrow DK}$ on KF CGS, in direction from DE/LU \rightarrow DK2 is calculated as follows:

$$ATC_{KF\ CGS, DE \rightarrow DK} = \alpha_i \cdot \min \left(\min \left(\frac{P_{\max\ thermal, DE}}{1 + LOSS_{DE} + LOSS_{XB}} + \frac{\min(AAC_{DE}^{Wind}, P_{\max\ thermal, DE} \times LOSS_{DE})}{1 + LOSS_{XB}}, P_{\max\ thermal, DE} \right), \frac{P_{\max\ thermal, XB}}{1 + LOSS_{XB}}, P_{\max\ thermal, DK} - AAC_{DK}^{Wind} \right) - AAC_{KF\ CGS, DE \rightarrow DK} + AAC_{KF\ CGS, DK \rightarrow DE}$$

The $ATC_{KF\ CGS, DK \rightarrow DE}$ on KF CGS, in direction from DK2 \rightarrow DE/LU is calculated as follows:

$$\begin{aligned}
& ATC_{KF\ CGS,DK\rightarrow\ DE} \\
= & \alpha_i \\
& \cdot \min \left(\min \left(\frac{P_{\max\ thermal,DK}}{1 + LOSS_{DK}} \right. \right. \\
& \left. \left. + \min(AAC_{DK}^{Wind}, P_{\max\ thermal,DK} \times LOSS_{DK}) \right), \right. \\
& \left. P_{\max\ thermal,DK} \right), P_{\max\ thermal, XB}, \frac{P_{\max\ thermal, DE} - AAC_{DE}^{Wind}}{1 - LOSS_{XB}}, \\
& \frac{P_{\max\ thermal, DE} - AAC_{DE}^{Wind}(1 - LOSS_{DE})}{1 - LOSS_{XB} - LOSS_{DE}} \left. \right) - AAC_{KF\ CGS,DK\rightarrow\ DE} \\
& + AAC_{KF\ CGS,DE\rightarrow\ DK}
\end{aligned}$$

When KF CGS is not in operation ($P_{\max\ thermal,DK}$, $P_{\max\ thermal,DE}$ or $P_{\max\ thermal, XB}$ is equal to zero) due to a planned or unplanned outage:

$$ATC_{KF\ CGS,DE\rightarrow\ DK} = 0$$

Where:

DE	:= Bidding zone DE/LU.
DK	:= Bidding zone DK2.
$ATC_{KF\ CGS,DE\rightarrow\ DK}$:= Available Transfer Capacity on KF CGS in direction DE/LU→DK2 provided to the day-ahead market.
$AAC_{KF\ CGS,DE\rightarrow\ DK}$:= Already Allocated and nominated Capacity for KF CGS in direction DE/LU→DK2, in accordance with Article 11.
$AAC_{KF\ CGS,DK\rightarrow\ DE}$:= Already Allocated and nominated Capacity for KF CGS in direction DK2→DE/LU, in accordance with Article 11.
AAC_{DE}^{Wind}	:= Expected wind generation on the OWF(s) from TSO forecast that is a part of bidding zone DE/LU and connected to the KF CGS, in accordance with Article 11.
AAC_{DK}^{Wind}	:= Expected wind generation on the OWF(s) from TSO forecast that is a part of bidding zone DK2 and connected to the KF CGS, in accordance with Article 11.
$CP_{OWF, DE}$	Connection Point of offshore windfarm connected in the bidding zone DE/LU to KF CGS.
$CP_{OWF, DK}$	Connection Point of offshore windfarm connected in the bidding zone DK2 to KF CGS.
$LOSS_{DE}$:= Electrical losses between the connection point of KF CGS in bidding zone DE/LU and $CP_{OWF, DE}$
$LOSS_{XB}$:= Electrical losses between the connection point in $CP_{OWF, DK}$ and $CP_{OWF, DE}$
$LOSS_{DK}$:= Electrical losses between the connection point of KF CGS in bidding zone DK2 and $CP_{OWF, DK}$
α_i	:= Availability factor of equipment defined through scheduled and unscheduled outages, α_i , being a real number in between and including 0 and 1.
$P_{\max\ thermal, DE}$:= Thermal capacity for line section from bidding zone DE/LU to $CP_{OWF, DE}$
$P_{\max\ thermal, XB}$:= Thermal capacity for line section from $CP_{OWF, DK}$ to $CP_{OWF, DE}$
$P_{\max\ thermal, DK}$:= Thermal capacity for line section from bidding zone DK2 to $CP_{OWF, DK}$

Following Electricity Balancing Regulation Articles 40, 41 or 42, CCR Hansa TSOs have the right to allocate capacity for the cross-zonal exchange of ancillary services (e.g. balancing products).

4.2.2 Capacity limitations originating from the AC grid handled by AHC in CCR Nordic

The capacity of a DC line (being a fully controllable active power flow) is a NTC by nature. CCR Nordic has decided to handle the power flows of DC lines with the AHC approach, see Annex 2. This means that the flows on the DC lines are competing for the scarce capacity on the AC grid, like the exchanges from any of the other Nordic bidding zones (SE1, SE2, NO1, FI, and so on).

The converter stations of the CCR Hansa DC interconnectors are modelled as ‘virtual’ bidding zones in the flow-based system (however a bidding zone, without production and consumption), having their own PTDF factors reflecting how exchanges on the DC lines are impacting the AC grid elements. Radial AC connections can be handled in the same way. This is illustrated in Figure 7.

CCR Nordic provides a flow-based representation of the AC grid in the Nordic area, which is imposing AC grid limitations on the commercial exchanges over the Hansa lines as well.

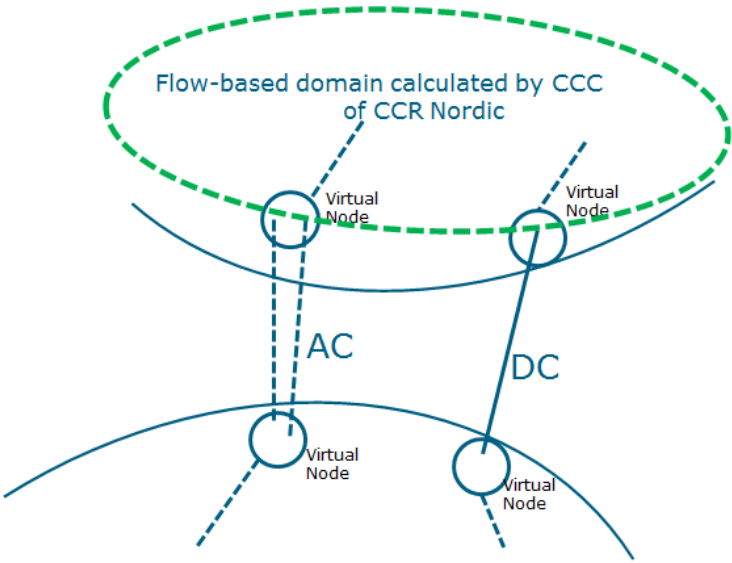

Figure 7: Advanced hybrid coupling in CCR Nordic

4.2.3 Capacity limitations originating from the AC grid handled by AHC in CCR Core

The capacity of a DC line (being a fully controllable active power flow) is a NTC by nature. CCR Core decided to handle the power flows of DC lines with the AHC¹³ approach as target model. This means that the flows on the DC lines are competing for the scarce capacity on the AC grid, like the exchanges from any of the other Core bidding zones (NL, DE, PL, FR, and so on). The converter stations of the CCR Hansa DC interconnectors are modelled as ‘virtual’ bidding zones in the flow-based system (a bidding zone without production and consumption), having their own PTDF factors reflecting how exchanges on the DC lines are impacting the AC grid elements. Radial AC connections can be handled in the same way. This is illustrated in Figure 8.

¹³ See Annex 2 for explanation of AHC

CCR Core provides a flow-based representation of the AC grid in the Core area, which is imposing AC grid limitations on the commercial exchanges over the Hansa lines as well.

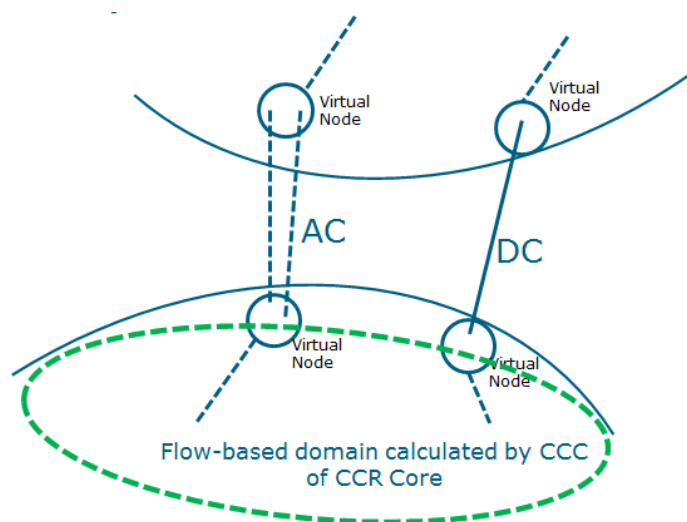

Figure 8: Advanced hybrid coupling in CCR Core

4.2.4 Further requirements from Article 21(1)(b) of the CACM Regulation

In the following section, the requirements set out in Article 21(1)(b) of the CACM Regulation for a detailed description of the capacity calculation approach are listed, and it is explained how the CCM of CCR Hansa fulfils these requirements.

(ii) rules for avoiding undue discrimination between internal and cross-zonal exchanges to ensure compliance with point 1.7 of Annex I to Regulation (EC) No 714/2009;

Article 5 in the CCM for CCR Hansa states the methodology for selecting CNEs and rules for avoiding undue discrimination between internal and cross-zonal exchanges. The CCR Hansa TSOs are in general responsible for identifying the CNEs that are relevant for capacity calculation. As the CCR Hansa CCM is based on a principle of applying CNTC on the cross-zonal grid elements while handling any relevant grid constraints in the meshed AC grid with flowbased, for which it is better than NTC, the CCR Hansa CCM will only include the CCR Hansa Interconnectors. The TSOs will, within the flow-based methodologies, include the AC grid CNEs that are relevant to monitor to ensure security of supply. This means that CCR Hansa relies on CCR Nordic and CCR Core to include these CNEs in the flow-based methodologies and the rules to avoid undue discrimination between internal and cross-zonal exchanges developed there.

As the internal flows within the bidding zones are to be handled via flow-based allocation in the adjacent CCRs, along with the representation of the CCR Hansa interconnectors with AHC, the allocation of capacity to the interconnectors will be based on a mathematical optimisation in the allocation process. Thus there is no possibility to discriminate one type of flow to another within CCR Hansa. Also taking into account that the methodology only includes the CCR Hansa Interconnectors as previously mentioned, there is no possibility to distinguish between internal and cross-zonal flows within the CCR Hansa CCM, which means there can be no discrimination.

(iii) rules for taking into account, where appropriate, previously allocated cross-zonal capacity;

The previously-allocated cross-zonal capacity can be subtracted from the actual CCR Hansa interconnector capacity which is described in section 4.7.

(iv) rules on the adjustment of power flows on critical network elements or of cross-zonal capacity due to remedial actions in accordance with Article 25;

In case it would be necessary to adjust the power flow on the CNEs taken into account in the CCM, it will be done by adjusting the cross-zonal capacity of the bidding-zone border where the remedial action has effect in either direction, as written in Article 10(7) in the CCM for CCR Hansa.

In case the remedial action is situated in the adjacent AC grid, it will be done by adjusting the size of the flow-based domain. The determination of where this adjusted flow-based domain is utilised will be left to the market allocation algorithm optimisation.

(v) for the flow-based approach, a mathematical description of the calculation of power transfer distribution factors and of the calculation of available margins on critical network elements;

Not applicable, as this will be handled in the flow-based methodologies of CCR Nordic and CCR Core.

(vi) for the coordinated net transmission capacity approach, the rules for calculating cross-zonal capacity, including the rules for efficiently sharing the power flow capabilities of critical network elements among different bidding-zone borders;

As the methodology chosen utilises flow-based domains from the two adjacent CCRs to ensure optimal market efficiency when handling constraints from the AC grids, there is no ex-ante split of capacity on CNEs. The methodology only takes cross-border elements and the radial lines associated with these into account, thus there are no CNEs of which the power-flow capabilities have to be shared. This is specified in Article 17 of the CCM for CCR Hansa.

(vii) where the power flows on critical network elements are influenced by cross-zonal power exchanges in different capacity calculation regions, the rules for sharing the power flow capabilities of critical network elements among different capacity calculation regions in order to accommodate these flows.

The use of AHC in CCR Core and CCR Nordic ensures that an economic optimisation determines where capacities are allocated between borders and different capacity calculation regions. The methodology only takes cross-border elements and the radial lines associated with these into account, thus there are no CNEs of which the power-flow capabilities have to be shared. This is specified in Article 17 of the CCM for CCR Hansa.

4.3 Methodology for determining the Transmission Reliability Margin

The methodology to determine the reliability margin, for cross-zonal capacity in CCR Hansa, includes the principles for calculating the probability distribution of the deviations between the expected power flows at the time of the capacity calculation, and realised power flows in real time, and subsequently specifies the uncertainties to be taken into account in the capacity calculation, being the TRM mentioned in section 4.2.1. The following description sets out common harmonised principles for deriving the reliability margin from the probability distribution, as required in Article 22(3) of the CACM Regulation.

Due to the controllability of the power flow over DC interconnections, the determination of a reliability margin does not need to be applied on bidding-zone borders only connected by DC interconnections. Therefore, on the borders SE4-PL and DK2-DE/LU no reliability margin is currently applied. The methodology described here therefore only applies to the radial-connected AC border DK1-DE/LU.

In general, the cross-border capacity derived for the AC border in CCR Hansa is expressed as an NTC value. During the capacity calculation, the CCR Hansa TSOs apply the TRM in order to hedge against risks inherent in the calculation. The methodology for the TRM is determined by the CCR Hansa TSOs and reflects the risks that the CCR Hansa TSOs are facing. As demanded by Article 22(2) of the CACM Regulation, the presented methodology in particular takes into account:

“(a) Unintended deviations of physical electricity flows within a market time unit caused by the adjustment of electricity flows within and between control areas, to maintain a constant frequency;
 (b) Uncertainties which could affect capacity calculation and which could occur between the capacity calculation time frame and real time, for the market time unit being considered.”

The TRM calculation consists of the following high-level steps:

1. Identification of sources of uncertainty for each TTC calculation process;
2. Derivation of independent time series for each uncertainty and determination of probability distributions (PD) of each time series;
3. Convolution of individual PDs and derivation of the TRM value from the convoluted PD.

The method is illustrated in the figure below.

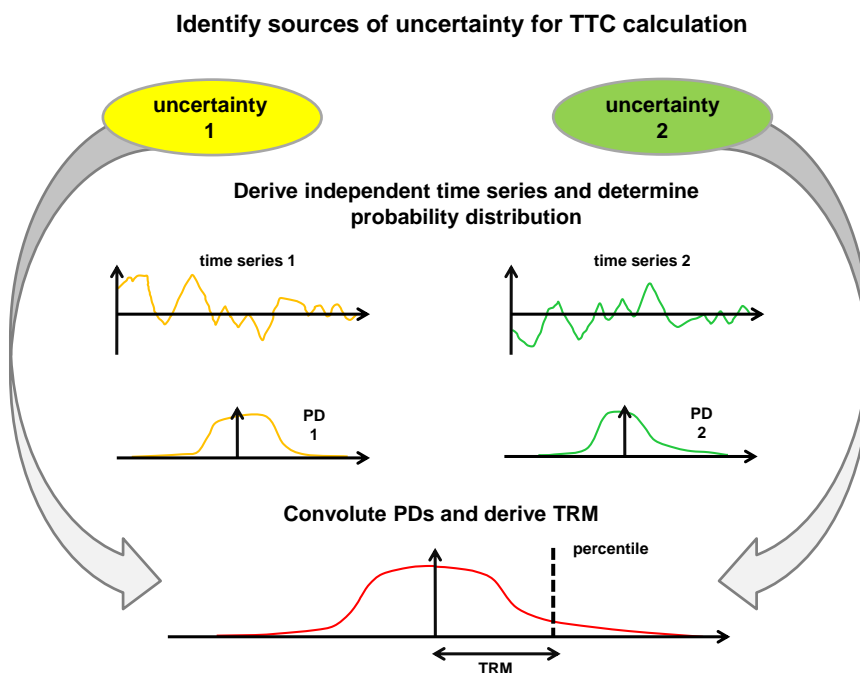

Figure 9: Illustration of the concept used to calculate the TRM

Below, the individual steps are described in more detail.

Step 1: Identification of sources of uncertainty

In the first step, the corresponding uncertainties are identified. In general, the TTC calculation is based on the CGM, which includes assumptions and forecasts for the generation and load pattern as well as for the grid topology. This is the starting point to identify specific sources of uncertainty. For the AC border in CCR Hansa, typical sources of uncertainty at the capacity calculation stage are:

1. Inaccuracy of forecasts for wind, load and solar infeed, which impact the load and generation pattern in the network model;
2. Assumptions of cross-border exchange between third countries which are not part of the TTC profile;
3. Exchange of frequency containment reserve (FCR).

Step 2: Determination of appropriate probability distributions

The second step of the TRM calculation is the determination of appropriate time series that measure or estimate the effect of each uncertainty on the TTC calculation. Depending on the nature of the uncertainty, the determination of such time series can differ. In general, generic time series from an

already existing data base can be used as a starting point. The time series cover an appropriate timespan from the past in order to get a significant and representative amount of data. After performing quality checks, the impact of the uncertainty on the TTC calculation is determined.

Step 3: Convolution and TRM calculation

At the beginning of this step, the individual PDs are convoluted to get the overall PD for an event. The convolution of the PDs of the relevant uncertainties merges the individual independent factors into one common PD for one TRM. Before the convolution is made, each PD is normalised. The convoluted PD is the basis for the determination of initial TRM values. From the convoluted PD, a certain percentile is taken.

4.4 Methodologies for determining operational security limits, contingencies relevant to capacity calculation and allocation constraints

In accordance with Article 23(1) of the CACM Regulation, CCR Hansa TSOs shall respect the operational security limits used in operational security analysis carried out in line with Article 72 of the SO Regulation. The operational security limits used in the common capacity calculation are the same as those used in operational security analysis, therefore any additional descriptions pursuant to Article 23(2) of the CACM Regulation are not needed.

In particular, the following operational security limits and contingencies shall be used in the operational security analysis:

- steady-state thermal limits
- voltage stability
- frequency and dynamic transient stability
- short-circuit ratio (SCR)
- security of supply (interaction with distribution network)
- identified and possible or already-occurred fault of the transmission system element
- identified and possible or already-occurred fault of the significant grid users if relevant for the transmission system operational security
- identified and possible or already-occurred fault of the distribution network element if relevant for the transmission system operational security

Steady-state thermal limits of CCR Hansa interconnectors are considered in the TTC calculation process described in the sections 4.2.1 and 5.1.1. Operational security limits and contingencies of adjacent AC grid elements, reflecting interactions between CCR Hansa interconnectors and the AC grids, are handled by the flow-based capacity calculation methodologies in CCR Core and CCR Nordic.

Operational security limits which cannot be evaluated in the frame of flow-based calculations of adjacent CCRs (e.g. voltage stability, dynamic stability, short-circuit limits, etc.) are assessed by individual CCR Hansa TSOs who perform the simulations in their offline tools using a CGM. The results are translated into cross-zonal capacity constraints, e.g. as constraints of particular virtual bidding zones representing CCR Hansa interconnectors, that are respected during capacity allocation.

In accordance with Article 23(3)(a) or (b) of the CACM Regulation, CCR Hansa TSOs, besides active power-flow limits on CCR Hansa interconnectors, may apply allocation constraints which means constraints to be respected during capacity allocation to maintain the transmission system within operational security limits or constraints that are needed to increase the efficiency of capacity allocation and that cannot not be translated into cross-zonal capacity limitations, including:

- The production in a bidding zone shall be above a given minimum production level

- The combined import or export from one bidding zone to other adjacent bidding zones shall be limited in order to ensure adequate level of generation reserves required for secure system operation
- Maximum flow change on DC-lines between MTUs (ramping restrictions)
- Implicit loss factors on DC-lines.

A minimum production level may need to be applied in a bidding zone in order to guarantee a minimum number of generators running in the system that are able to supply reactive power needed for voltage support or to safeguard sufficient inertia to ensure dynamic stability.

Allocation constraints may include balancing constraints (import/export limits) that are determined for those systems where a central dispatch market model is applied, i.e. where the CCR Hansa TSO acts as the balance responsible party for the whole control area and procures reserves in an integrated scheduling process run after the day ahead market closure. In order to execute this task, the CCR Hansa TSO in central dispatch systems needs to ensure the availability of sufficient upward or downward regulation reserves for maintaining secure power system operation. This takes form of allocation constraints that vary depending on the foreseen balancing situation. Application of allocation constraints to reflect balancing constraints in capacity allocation process ensures efficiency in distribution of balancing constraints on interconnections and maximise social welfare. For details see Annex 1.

Implicit loss factor on DC lines during capacity allocation ensures that the DC line will not flow unless the welfare gain of flowing exceeds the costs of the corresponding losses (currently not implemented).

A ramping restriction is an instrument of system operation to maintain system security (frequency management purposes). This sets the maximum change in DC flows between MTUs (max. MW/MTU per CCR Hansa interconnector) on an hour-to-hour basis.

The allocation constraints are included during the capacity allocation process and one allocation constraint can influence the interconnections belonging to the different CCRs.

The application of allocation constraints on one or more Hansa bidding zone borders (BZBs) will in most cases have an impact on the whole of CCR Hansa.

In view of such likely impacts, and principles of transparency and reliability of information, ref. to e.g. Article 3(f) of the CACM Regulation, Hansa TSOs, planning on allocation constraints, are to inform market participants, other Hansa TSOs (not planning the allocation constraints), and all Hansa NRAs, on the plans for application of allocation constraints on Hansa BZBs according to Article 8(6).

If the relevant Hansa TSOs fail to follow this information procedure within the set timeline, the application of the allocation constraints in question may be deemed non-valid.

“Detailed descriptions and justifications” to accompany the information on allocation constraints refers to the substantial requirements for the relevant allocation constraint(s), referred to in Article 8(2) to (5), ref. to Article 8(1)(a) to (d), in the DA&ID CCM, and in Article 23(3)(a) or (b) of the CACM Regulation. Thus, the criteria, “economic surplus for single day-ahead or intraday coupling”, within Article 23(3)(b) of the CACM Regulation, also refers to the definition thereof, in Article 2(46) of the CACM Regulation.

4.5 Methodology for determining the generation shift keys

The generation shift keys used to calculate the TTC values in CCR Hansa represent the best forecast of the relation of a change in the net position of a bidding zone to a specific change of generation or load in the common grid model. Due to the nature of the CCR Hansa interconnectors, the generation shift keys are applied to calculate the TTC values of the bidding-zone borders connected by CCR Hansa AC interconnectors.

On the radial AC connection between DK1 and DE, the GSKs of DK1 and DE, defined in the CCR Nordic and CCR CORE respectively, are applied to represent the distribution of the power flow between the different cross-border lines.

Any interaction between the CCR Hansa interconnectors and the adjacent AC grids, as described in 4.2, is modelled in the corresponding flow-based methodologies of CCR Core and CCR Nordic and is therefore not a part of this methodology.

4.6 Methodology for determining remedial actions to be considered in capacity calculation

When considering the use of remedial actions in capacity calculation, it is important to first and foremost understand the objective. The overall objective is to increase the economic efficiency of the European allocation process, thus to give the market coupling algorithm as little constraint as possible while still ensuring system security.

Remedial actions are normally split into two categories, costly remedial actions such as countertrading and redispatching and non-costly remedial actions which include topological changes, modifying duration of planned outages, voltage control and manage reactive power or use of phase shifters. The CCM requires CCR Hansa TSOs to include non-costly remedial action, while costly remedial actions are not required specifically to be used for capacity calculation.

In CCR Hansa, only the cross border lines are represented in capacity calculation, and capacity is given to the market in accordance with the mathematical description of sections 4.2.1 and 5.1.1.

In the CCM of CCR Nordic, the inclusion of CNEs in the flow-based capacity calculation is dependent on assessment of whether it is needed from a security of supply reason or if it is socioeconomically feasible to include the CNE as a constraint of the flow-based domain. If a CNE is not included in the flow-based domain, any congestion of this CNE will have to be handled by use of remedial actions when a security analysis shows that it is needed.

In the CCM of CCR Core, a different approach is taken. On all CNECs included in the flow-based domain, a certain level of capacity is reserved for cross-border exchanges. After capacity allocation, a security analysis will show if the use of remedial action is needed to handle congestions in the grid.

In CCR Hansa there are no bidding zone internal CNEs included in the capacity calculation. Subsequently there are very limited possibilities to use remedial actions. Since the connection is radial, there cannot be a loop flow between the bidding zones DK1 and DE/LU. This leaves very little necessity to influence capacity on the radial AC connection and no necessity on the DC connections.

It is important to highlight that the CCR Hansa CCM aims at giving a maximum amount of capacity on the bidding-zone borders to the market. And given the scope of CCR Hansa CCM, there are only few possible limitations to the capacity calculated. When full capacity is given based on the conditions, then remedial actions will not be able to increase it, provided that capacity given to the market has to be kept within the physical possibilities.

In CCR Hansa, there are currently phase shifters in operation on the 220kV lines between DK1 and DE/LU. These are planned to be removed when the 220kV grid is upgraded to 400kV. After this, there will be no remedial actions available within CCR Hansa which can be utilised to influence the flow distribution on the cross-border lines. The impact of remedial actions that become available in the future will be considered in the determination of the TTC value as shown in section 4.2.1. Furthermore, it is important to note that the remedial actions found in bidding zones, in general, will be taken into account in the flow-based methodologies of CCR Nordic and CCR Core to enlarge the overall flow-

based domains in the favoured market direction. This will, in turn, also positively impact the cross-border capabilities of CCR Hansa if it increases the European economic welfare.

In terms of using costly remedial actions, redispatching within a bidding zone will have no effect on the radial AC connection or the two DC connections in CCR Hansa. Redispatching of generation can generally not influence the capacity on a DC line. The location of the generation assets and thereby the use of redispatching is however of importance when addressing internal constraints within bidding zones. In these cases, the redispatching should be utilised by CCR Nordic or CCR Core in enlarging the flow-based domains, as described above, prior to capacity allocation and to handle violation of operational security limits after the operational security analysis.

Regarding countertrading, this could to some extent be used for capacity calculation but it will generally bring market capacities beyond the physical possibilities when used in capacity calculation in CCR Hansa and is subsequently not used for this purpose.

Given the chosen capacity calculation methodology being a C-NTC methodology, the three contributions (CCR Core FB domain, CCR Hansa C-NTC CC and CCR Nordic FB domain) are independent inputs into the determination of admissible flows across the CCR Hansa bidding-zone borders. Subsequently there is no need, in capacity calculation, to do simultaneous actions across the CCR Hansa bidding-zone borders. In case CCR Hansa TSOs plan simultaneous activations of remedial actions on both sides of the CCR Hansa bidding-zone border, this will still not lead to the CCR Hansa capacity calculation to be influenced. It will impact the flow-based domain of CCR Nordic or CCR Core and can thereby influence the capacity that can be allocated on the CCR Hansa borders by the market coupling, but the change is realised in the size of the flow-based domains provided to the allocation mechanism.

4.6.1 Remedial actions to maintain anticipated market outcome on KF CGS

On the KF CGS, wind forecasts will be used to predict how much generation will be expected from the wind farms on KF CGS. This generation is the anticipated market outcome. This anticipated market outcome is used in the capacity calculation on KF CGS. The capacity given will have to be maintained by TSOs, thus the TSOs will use countertrading or redispatching, depending on the situation, to maintain capacity in case the wind forecasts are incorrect. This approach for KF CGS is compliant with the Commission Decision (EU) 2020/2123 of 11 November 2020 on the derogation for KF CGS following Article 64 of Regulation (EU) 2019/943.

4.7 Rules for taking into account previously allocated cross-zonal capacity in the day-ahead time frame

The CCR Hansa TSOs shall include the following as already allocated capacity (ACC) in the capacity calculation following the mathematical descriptions:

- a. Capacity allocated for nominated Physical Transmission Rights (PTRs); and
- b. Capacity allocated for cross-zonal exchange of ancillary services, following Electricity Balancing Regulation Articles 40, 41 or 42, except those ancillary services in accordance with Article 22(2)(a) of the CACM Regulation.
- c. For KF CGS, AAC^{WIND} is the expected wind generation on the OWF(s) based on the relevant CCR Hansa TSOs forecasts.

It is important to consider that the mathematical description indicates that AAC can both be added or subtracted from the cross-border capacity depending on the direction of the AAC.

A similar rule is specified for intraday in section 5.6.

4.8 Fallback procedure for day-ahead capacity calculation

According to Article 21(3) of the CACM Regulation, the capacity calculation methodology shall include a fallback procedure for any cases where the initial capacity calculation does not lead to any results.

As mentioned in section 4.2, the capacity calculation takes into account three different parts of the grid. This also implies that the fallback procedure for capacity calculation should be applied in cooperation with the adjacent CCRs.

In case the capacity calculation cannot be performed by the CCC, the concerned CCR Hansa TSOs will bilaterally calculate and agree on cross-zonal capacities. CCR Hansa TSOs will individually apply the CCM, and the results will be selected by CCR Hansa TSOs by using the minimum value of adjacent CCR Hansa TSOs of a bidding-zone border. The concerned CCR Hansa TSOs shall submit the capacities to the relevant CCC and to the other CCR Hansa TSOs.

5. Capacity calculation methodology for the intraday time frame

This chapter describes the target capacity calculation methodology which will be applied for CCR Hansa bidding-zone borders in the intraday time frame.

5.1 Description of the capacity calculation methodology in CCR Hansa

The capacity calculation methodology for the intraday time frame in CCR Hansa is equal to the one described for the DA time frame in Section 4.2. This implies that CCR Hansa calculates the capacity for the CCR Hansa interconnectors, while the limitations from AC grids, in the possible extent, are handled by adjacent CCRs. For CCR Hansa, the target model is reached when XBID is able to handle flow-based constraints.

5.1.1 Mathematical description of the applied approach

The only difference with the mathematical description for the intraday time frame compared to the day-ahead time frame (see section 4.2.1), is in the Already Allocated and nominated Capacity (AAC), as explained hereunder.

On the intraday time frame, this AAC consists of the nominated Physical Transmission Rights for a bidding-zone border in direction A→B, the additionally nominated cross-zonal capacity during the single day-ahead coupling and potentially capacity allocated for the cross-zonal exchange of ancillary services.

5.1.2 Capacity limitations originating from adjacent AC grid

The same rules and conditions stated in sections 4.2.2 and 4.2.3 for day-ahead will apply for intraday. It is up to CCR Nordic and CCR Core to represent the flow limitations in the AC grids, while the actual CCR Hansa interconnector capacities are addressed individually within CCR Hansa. Together these three inputs will constitute the limitations on the CCR Hansa interconnectors to be respected in the capacity allocation process.

5.1.3 Further requirements from Article 21(1)(b) of the CACM Regulation

In the following section, the requirements set out in Article 21(1)(b) of the CACM Regulation for a detailed description of the capacity calculation approach are listed and a description is given how these are taken into account.

(ii) rules for avoiding undue discrimination between internal and cross-zonal exchanges to ensure compliance with point 1.7 of Annex I to Regulation (EC) No 714/2009;

Article 14 in the CCM for CCR Hansa states that the methodology for selecting CNEs and the rules for avoiding undue discrimination between internal and cross-zonal exchanges shall follow the rules of the day-ahead section. This is described in section 4.2.4.

(iii) rules for taking into account, where appropriate, previously allocated cross-zonal capacity;

The previously-allocated cross-zonal capacity can be subtracted from the actual CCR Hansa interconnector capacity which is described in section 5.6

(iv) rules on the adjustment of power flows on critical network elements or of cross-zonal capacity due to remedial actions in accordance with Article 25;

In case it would be necessary to adjust the power flow on the CNEs taken into account in the CCM, it will be done by adjusting the cross-zonal capacity of the bidding-zone border where the remedial action has effect in either direction, as written in Article 14 in the CCM for CCR Hansa.

In case the remedial action is situated in the adjacent AC grid, it will be done by adjusting the size of the flow-based domain. The determination of where this adjusted flow-based domain is utilised will be left to the market allocation algorithm optimisation.

(v) for the flow-based approach, a mathematical description of the calculation of power transfer distribution factors and of the calculation of available margins on critical network elements;

Not applicable, as this will be handled in the flow-based methodologies of CCR Nordic and CCR Core.

(vi) for the coordinated net transmission capacity approach, the rules for calculating cross-zonal capacity, including the rules for efficiently sharing the power flow capabilities of critical network elements among different bidding-zone borders;

As the methodology chosen utilises flow-based domains from the two adjacent CCRs to ensure optimal market efficiency when handling constraint from the AC grids, there is no ex-ante split of capacity on CNEs. This is specified in Article 17 of the CCM for CCR Hansa.

(vii) where the power flows on critical network elements are influenced by cross-zonal power exchanges in different capacity calculation regions, the rules for sharing the power flow capabilities of critical network elements among different capacity calculation regions in order to accommodate these flows.

The use of AHC in CCR Core and CCR Nordic ensures that an economic optimisation determines where capacities are allocated between borders and different capacity calculation regions. This is specified in Article 17 of the CCM for CCR Hansa.

5.2 Methodology for determining the Transmission Reliability Margin

The same methodology for the determination of the reliability margin applies, as described for the day-ahead time frame in section 4.3.

5.3 Methodologies for determining operational security limits, contingencies relevant to capacity calculation and allocation constraints

The methodologies for the intraday time frame for determining operational security limits, contingencies relevant to capacity calculation and allocation constraints are the same as for the day-ahead time frame, see section 4.4.

5.4 Methodology for determining the generation shift keys

The methodology for the intraday time frame for determining the generation shift keys is the same as for the day-ahead time frame, see section 4.5.

5.5 Methodology for determining remedial actions to be considered in capacity calculation

See section 4.6.

5.6 Rules for taking into account previously allocated cross-zonal capacity in the intraday time frame

In addition to the list specified for the day-ahead in section 4.7, the CCR Hansa TSOs shall, in addition, include capacity allocated and nominated to the day-ahead market.

It is important to consider that the mathematical description indicates that AAC can both be added or subtracted from the cross-border capacity depending on the direction of the AAC.

5.7 Intraday reassessment frequency

The frequency of the reassessment of intraday capacity shall be dependent on the availability of input data relevant for capacity calculation, as well as any events impacting the capacity on the cross-zonal lines.

According to Article 29 of the CACM Regulation, the capacity for the intraday time frame must be calculated by the CCC based on a common grid model (CGM). This can lead to both an increase or a decrease of capacity.

The availability of input data for the common grid model, wind forecasts and measurements of wind generation in relation to Krieger's flak as well as events, e.g. unscheduled outages, influence the cross-zonal capacity and are therefore likely to influence the intraday capacity reassessment frequency.

All TSOs in each capacity calculation region shall ensure that cross-zonal capacity is recalculated within the intraday market time frame based on the latest available information, including unexpected events and taking into consideration efficiency and operational security. The CCC shall ensure that the adjusted capacities are submitted without undue delay to the MCO.

On the 24th of April 2018, ACER made their decision on the All TSOs proposal for intraday cross-zonal gate opening and intraday cross-zonal gate closure time following CACM Regulation Article 59 deciding on a common European intraday cross-zonal gate opening time (IDCZGOT) at 15:00 D-1 CET.

The CCR Hansa TSOs commit themselves to provide the market with information on when capacity for the SIDC will be released by 30 days after the approval of this capacity calculation methodology. If CCR Hansa TSOs cannot release cross-zonal capacity by the IDCZGOT, the CCR Hansa TSOs will provide justification for the delay and specify when cross-zonal capacity will be released.

5.8 Fallback procedure for intraday capacity calculation

The fallback procedure for capacity calculation for the intraday time frame is the same as for the day-ahead time frame, see section 4.7.

6. Methodology for the validation of the cross-zonal capacity for both day-ahead and intraday according to Article 26

The target model of the capacity calculation for CCR Hansa limits the scope of the capacity calculation for CCR Hansa to the interconnections themselves. Therefore, this section only describes the methodology for validating the part of the cross-zonal capacity that is actually calculated by the CCR Hansa CCC.

In accordance with Article 26(1,3), each CCR Hansa TSO shall validate and have the right to reduce cross-zonal capacity relevant to the TSO's bidding-zone borders provided by the CCC. Each CCR Hansa TSO may reduce cross-zonal capacity during the validation of cross-zonal capacity relevant to the CCR Hansa TSO's bidding-zone borders for reasons of operational security. Additionally, each CCR Hansa TSO has the right to propose increases in the cross-zonal capacity. Any increase in capacity following this validation process shall be coordinated by the CCC and commonly agreed upon by the affected CCR Hansa TSOs. The affected CCR Hansa TSO will normally mean the CCR Hansa TSOs directly involved on the specific bidding-zone border in question.

The CCR Hansa TSOs are legally responsible for the cross-zonal capacities. The validation of the interconnection capacity, which is calculated by the CCC, will be performed by each concerned CCR Hansa TSO. The validation of cross-zonal capacity and allocation constraints ensure that the results of the capacity allocation process will respect operational security requirements.

The CCR Hansa TSOs will consider the operational security limits when performing the validation, but may also consider additional grid constraints, grid models and other relevant information. The CCR Hansa TSOs may use, but are not limited to, the tools developed by the CCC for analysis. Thus, the CCR Hansa TSOs might also employ verification tools not available to the CCC. Validation of the results shall include a check of whether the correct data provided by CCR Hansa TSOs was used by the CCC in the capacity calculation process. The CCC of CCR Nordic and CCR Core can, for example, deliver minimum and maximum net positions for each virtual bidding zone, which will allow for CCR Hansa TSOs to compare restrictions imposed on the CCR Hansa interconnectors from the AC grids with the capacity calculation made by the CCR Hansa CCC.

Results from the validation process shall be sent from each CCR Hansa TSO to the CCC of CCR Hansa and at the same time to all CCR Hansa TSOs within a time limit to be agreed upon by all CCR Hansa TSOs. All such decisions from CCR Hansa TSOs on reduction of capacity and proposals for increase of capacity shall include an explanation and justification.

The CCC will coordinate with adjacent CCCs during the capacity calculation and validation process to ensure that the correct input data has been used, and subsequently that the capacities are within a plausible solution space in line with Article 26(4).

Any information on increased or decreased cross-zonal capacity from adjacent CCCs will be provided to the CCR Hansa TSOs to be taken into account during the validation.

If capacities on a given bidding-zone border are regularly corrected by CCR Hansa TSOs, the CCR Hansa TSOs shall jointly evaluate the capacity calculation process and the capacity calculation methodology, and investigate how to reduce the need for corrections.

The CCR Hansa CCC shall every three months report all reductions made during the validation of cross-zonal capacity to all CCR Hansa NRAs. The report shall include the location and amount of any reduction in cross-zonal capacity and shall give reason for the reductions, following the requirements in CACM Regulation Article 26(5).

According to the CACM Article 26(2), the CCM shall include a rule for splitting the correction of cross-zonal capacity between the different bidding zones when using a coordinated NTC methodology. As the CCR Hansa CCM does not include any ex-ante splitting of capacity due to the utilisation of AHC, there will be no need to split a correction of cross-zonal capacity either.

7. Evaluation of the CCM in light of the objectives of the CACM Regulation

This chapter contains a description of how the draft proposal meets the aims of the CACM Regulation as stated in Article 3.

The CACM Regulation has the objective to ensure optimal use of the transmission infrastructure, operational security and optimising the calculation and allocation of cross-zonal capacity.

The Advanced Hybrid Coupling methodology for CCR Hansa secures optimal use of the transmission capacity as it takes advantage of the flow-based methodologies developed in CCR Nordic and CCR Core in order to represent the limitations in the AC grids, while the actual CCR Hansa interconnector capacities are addressed individually within CCR Hansa. The use of CCR Hansa interconnector capacity and AC grid capacity is fully integrated in this way, thereby providing a fair competition for the scarce capacities in the system and an optimal system use. Indeed, there is no predefined and static split of the CNE capacities, and the flows through CCR Hansa from CCR Core and CCR Nordic are decided based on economic efficiency during the capacity allocation phase.

The CCM treats all borders in CCR Hansa and adjacent CCRs equally and thus provides non-discriminatory access to cross-zonal capacity. It creates a basis for a fair and orderly market and fair and orderly price formation by implementing a simple CCM solution which is integrated with the methodologies of the adjacent CCRs.

The methodology complies with all requirements for operational security and defines methodologies for determining reliability margins, generation shift keys and operational security limits.

The proposal for capacity calculation and allocation in CCR Hansa takes advantage of flow-based capacity calculation for the AC grids while also ensuring full transparency of the calculation of actual CCR Hansa interconnector capacity. This will, in turn, result in a better understanding and increase the transparency and reliability of information on the CCR Hansa borders.

The capacity calculation methodology has no negative consequences on the development of capacity calculation methodologies in CCR Nordic and CCR Core and can evolve dynamically with the development and merger of CCRs in the future. The methodology therefore does not hinder an efficient long-term operation in CCR Hansa and adjacent CCRs and the development of the transmission system in the Union.

8. Timescales for implementation

Due to their location and the radial structure, the interconnectors between DK1-DE/LU, DK2-DE/LU and SE4-PL can be considered independent from another. This allows the CCR Hansa TSOs to initially continue to use their current processes and implement the new CCM in a stepwise manner in order to improve the capacity calculation whenever possible. Current practices are already approved (or at least accepted) by NRAs on both sides of the CCR Hansa interconnector and are not subject to new approval.

The first improvements are in terms of input and process coordination, while the second set of improvements utilises the flow-based projects of CCR Nordic and CCR Core in order to reflect the limitations from the AC grids on CCR Hansa interconnectors.

The implementation of the CCM in CCR Hansa will be done in parallel with the implementation of the CCMs (with AHC) in CCR Nordic and CCR Core.

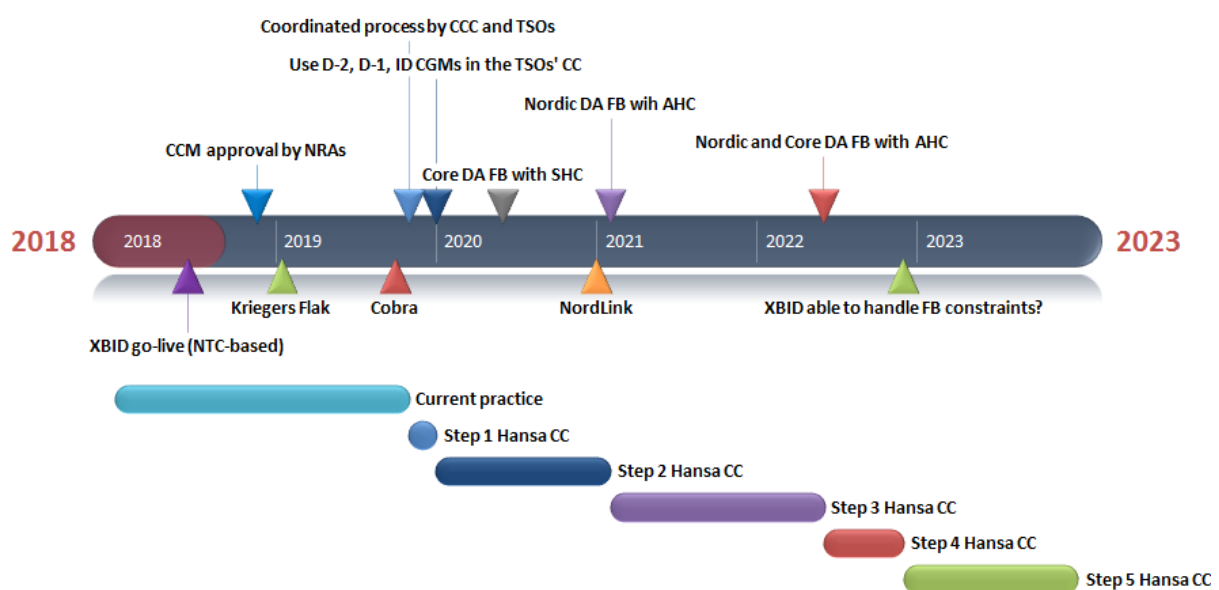

Figure 10: Indicative timeline for the implementation of the CCR Hansa CCM

Current practice:

Following the approval of the capacity calculation methodology by the relevant NRAs, the CCR Hansa TSOs will start the implementation of improvements of the current processes to ensure a smooth and efficient transition towards one common capacity calculation process in coordination with the CCRs Nordic and Core. Up to the introduction of the D-2, D-1, and ID CGMs, the current capacity calculation applied in the Hansa region continues as is.

Implementation of CCM for CCR Hansa consists of the following steps:

Step 1:

As a first step, the CCR Hansa TSOs will use the appointed CCC to further coordinate the capacity calculation process. The CCC will calculate the CCR Hansa interconnector capacity while the CCR Hansa TSOs will send the results from their capacity calculations on the AC grid to the CCC. The minimum value will prevail and will be calculated by the CCC. The resulting cross-zonal capacities are subject to validation by each CCR Hansa TSO for its bidding-zone borders. The CCC provides the validated cross-zonal capacities to the allocation mechanism.

Step 2:

With the introduction of the D-2, D-1, and ID CGMs, as a first improvement, all CCR Hansa TSOs will use the same common grid model as input in their CCR Hansa related capacity calculation processes. This will ensure that the forecast of demand, generation and line availability is the same, thus increasing the coordination on the capacity calculation.

Step 3:

The third step of the CCR Hansa capacity calculation implementation comes with the go-live of the Nordic flow-based capacity calculation. The power flows in the surrounding AC grid on the Nordic side stemming from the CCR Hansa lines will be taken into account by the AHC in the flow-based capacity calculation of CCR Nordic. This replaces the NTC calculation done by the CCR Hansa TSOs on the Nordic side of the Hansa lines. Possible interdependencies between trade on CCR Hansa borders and trade on CCR Nordic borders are represented in the flow-based domains. At this point in the implementation of the CCR Hansa CCM, a testing phase of 6 months of data will be coordinated with CCR Nordic.

It is assumed that the capacity calculation for the Nordlink CCR Hansa interconnector will be the responsibility of the CCR Hansa. In the Nordic flow-based capacity calculation, the impact of Nordlink on the AC grid in the Nordic region is modelled with AHC. However, until the operation of AHC in the Core region, the impact of Nordlink on the AC grid in the Core region will be modelled in the capacity calculation process of the responsible CCR Hansa TSO. Therefore, the previous bilateral NTC process is changed to a C-NTC process, coordinated between all affected CCR Hansa TSOs.

Step 4:

Step four in the CCR Hansa CC implementation is the introduction of AHC in CCR Core. At this point, CCR Nordic and CCR Core model the impact of the CCR Hansa interconnectors on the AC grid in the Nordic and the Core region with AHC in the respective flow-based capacity calculation processes. Operational security limits (e.g. voltage and dynamic stability) which cannot be evaluated in the frame of flow-based calculations are assessed by individual CCR Hansa TSOs as the external constraints of particular virtual bidding zones representing CCR Hansa interconnectors and respected during capacity allocation. The CCR Hansa CCC is responsible for calculating the capacity of the CCR Hansa interconnectors themselves and for cooperation with the adjacent CCCs of CCR Nordic and CCR Core. At this point in the implementation of the CCR Hansa CCM, a testing phase of 6 months of data will be coordinated with CCR Core.

Step 5:

At the moment it is uncertain when XBID will be able to handle flow-based parameters. This means that flow-based constraints will have to be translated to NTC constraints in intraday, but it is expected that in a later stage, flow-based constraints will be utilised in the ID CC as well. At this point in the implementation of the CCR Hansa CCM, a testing phase of 6 months of data is expected to be done within the XBID project.

It is foreseen that new bidding-zone borders will enter into CCR Hansa between the steps 1 - 5 described above. For these new borders, relevant methods for capacity calculation are subject to NRA approval from the two relevant NRAs. These agreed practices should be accepted as "current practices" in CCR Hansa, to be used until the appropriate steps are reached in the implementation of the CCM in Hansa. This ensures equal treatment of new and current Hansa bidding-zone borders, and respect the necessary stepwise approach.

9. Results from consultation

Comment number	Reviewer (Organisation)	Comments received	CCR Hansa TSOs' reply
1	EFET/Eurelectric/Nordenergi/Market parties platform/Statkraft	<p>The methodology for the DA timeframe is not sufficiently well described in Chapter 1. It starts with a “mathematical description” in Article 3. However, then the article 5 contains a general description of some issues that seem to incline that the capacities can be reduced, but that are not covered by the mathematical description. Article 5.2 allows TSOs to reduce the capacity based on individual assessment. There is no method described that explains how these reductions are calculated. The impact of article 5.1 on the capacity is unclear. However, article 5.2 refers to article 5.1 and therefore it seems that article 5.1. can also result in reductions of the capacities. In particular, it seems that the CCM for the CCR Hansa is made subordinate to the CCM of the CCRs Core and Nordic. Which could mean that available capacities in the CCR Hansa are reduced to manage congestions in the Core and Nordic region. Moreover, article 5 does not contain precise methods to calculate capacities. The title of Article 7 says that it describes the methodology for determining remedial actions, however it does not. It only says that the CCC can consider remedial actions</p>	<p>In order to increase transparency, the reasoning behind Article 5 has been rewritten including clear examples.</p> <p>Whereas numbers 7 and 8 have been rewritten to clearly state that the application of AHC ensures that CCR Hansa bidding-zone borders will be treated equally to bidding-zone borders in the flow-based capacity calculation methodologies, thus ensuring that the CCR Hansa bidding-zone borders are not given preferential treatment nor are they discriminated against compared to CCR Core or CCR Nordic bidding-zone borders.</p> <p>As CCR Hansa consists of only radial lines, and because the methodology aims at giving maximum capacity to the market, remedial actions are only taken into account when they can influence the flow distribution on the timelines on the AC border. Article 7 has been rewritten to clarify this.</p>
2	EFET/Eurelectric/Nordenergi/Market parties platform/Statkraft	<p>The definition of “Advanced Hybrid Coupling” in Article 2(1.a) is unclear. The term AHC is only used in Article 13. Article 13(c) suggests that the capacity for the lines in the CCR Hansa are determined by the CCM of CCR Nordic and CCR Core. It suggests that congestions in the Core and Nordic region are managed by limiting cross-zonal trade through the Hansa interconnectors. This is not acceptable. In the Whereas, number 12 (page 3) it is mentioned that AHC is needed to avoid undue discrimination between flows within CCR Hansa or adjacent regions and between bidding zone borders within CCR Hansa. However, there is no justification for this statement. Actually the opposite seems true. By applying AHC, cross-zonal trade between the Nordic and Core regions is discriminated against trades within</p>	<p>In order to minimise concerns about discrimination of flows, which is not the case of AHC, CCR Hansa has prepared an additional annex to the explanatory document, which explains AHC in depths and its benefits for capacity calculation in CCR Hansa. As well, the capacity will be reassessed in ad-hoc basis, in case of unexpected events.</p>

Comment number	Reviewer (Organisation)	Comments received	CCR Hansa TSOs' reply
		the Nordic CCR and against trades within the Core CCR.	
3	EFET/Eurelectric/Nordenergi/Market parties platform/Statkraft	The methodology for the ID timeframe has similar shortcomings as for the DA timeframe. It starts with a mathematical description in Article 8. But then article 10 introduces the same possibilities to reduce capacities without a method being described.	Similar changes as proposed for day-ahead have also lead to adjustments in the intraday section.
4	EFET/Eurelectric/Nordenergi/Market parties platform/Statkraft	Article 9 does not specify the frequency of reassessment of capacity in the intraday timeframe. This is not compliant with Article 21(2).	Article 9 has been rewritten to make this more clear.
5	EFET/Eurelectric/Nordenergi/Market parties platform/Statkraft	Article 11 gives additional possibilities to TSOs to reduce the capacities. Again there is no method described.	CACM Regulation gives the CCR Hans TSOs the obligation to validate the cross-zonal capacity calculated by the CCC, and the CCR Hansa TSOs do also have the right to correct the cross-zonal capacities.
6	EFET/Eurelectric/Nordenergi/Market parties platform/Statkraft	Article 3 (top of page 5) mentions the application of a TRM for a DC line. Article 4 however mentions that the methodology for determining the TRM applies solely to the AC lines. This is unclear.	This is an unfortunate mistake, and Articles 3 and 8 have been rewritten.
7	EFET/Eurelectric/Nordenergi/Market parties platform/Statkraft	In conclusion: The proposed CCM is a general description of the status quo. Approving this proposal would mean a formal endorsement of the current "black-box" approach in calculation capacities in the Hansa region. This method entails a clear risk that TSOs will "calculate" low capacities in order to manage internal congestions. There is no indication at all that the proposed "method" will result in justified (in terms of efficiency and non-discrimination) results. This proposal could even be labelled as "misleading" as the mathematical description with formulas in articles 3 and 8 does not cover the full calculation process. Finally, the proposal is not sufficiently detailed. The proposal does not meet the CACM requirements.	With the corrections/ adjustments made to the methodology, and together with a new annex to explain AHC, the CCR Hansa TSOs seek to de-mystify the "black-box" and to provide a more transparent capacity calculation methodology. The CCR Hansa TSOs are aiming at giving as much capacity as possible to the market.
8	EFET/Eurelectric/Nordenergi/Market parties platform/Statkraft	This method must be completely revised and needs elaborated. It is proposed to take a similar principle as proposed by the Channel region. In this approach, the capacity is set as the "MPTC" (maximum permanent technical capacity which is the maximum continuous active power which a network element (interconnector/HVDC system) is	The CCR Hansa TSOs have prepared a methodology which will seek to maximise the cross-border capacity and in close coordination with the capacity calculation methodologies of CCR Core and CCR Nordic. CCR Hansa TSOs do not see a significant difference in the treatment of DC cross-zonal capacity in CCR Hansa and CCR Channel.

Comment number	Reviewer (Organisation)	Comments received	CCR Hansa TSOs' reply
		capable of transmitting). Basically, this would mean that Articles 3 and 8 are kept, but that most other articles (like 5 and 11) are removed.	
9	EFET/Eurelectric/Nordenergi/Market parties platform	General comments as stated in chapter 1 of the reviewers' consultation document.	<p>CCR Hansa TSOs believe that the methodology consulted on is in compliance with the CACM Regulation, but there may be areas of the methodology which are not sufficiently explained and therefore, was in need of elaboration and adjustment. To overcome this, the CCR Hansa TSOs have, to the greatest extent, taken the comments on board where they are found to be helpful in the endeavour to submit a capacity calculation methodology for the bidding-zone borders in CCR Hansa which fulfils the objectives and meets the requirements as set out in the CACM Regulation.</p> <p>CCR Hansa finds that a significant part of the comments received are justified and will lead to improvements of the methodology described. Some comments are found to be caused by misunderstandings of the legal proposal which means that CCR Hansa TSOs improved and elaborated on the descriptions and explanations given.</p>

Annex 1: Justification of usage and methodology for calculation of allocation constraints in PSE

Allocation constraints in Poland are applied as stipulated in Article 8(3) of the CCM. These constraints reflect the ability of Polish generators to increase generation (potential constraints in export direction) or decrease generation (potential constraints in import direction) subject to technical characteristics of individual generating units as well as the necessity to maintain minimum generation reserves required in the whole Polish power system to ensure secure operation. This is explained further in subsequent parts of this Annex.

Rationale behind implementation of allocation constraints on PSE side

Implementation of allocation constraints as applied by PSE side is related to the fact that under the conditions of integrated scheduling based market model applied in Poland (also called central dispatch system) responsibility of Polish TSO on system balance is significantly extended comparing to such standard responsibility of TSO in so-called self-dispatch market models. The latter is usually defined up to hour-ahead time frame (including real time operations), while for PSE as Polish TSO this is extended to short (intraday and day-ahead). Thus, PSE bears the responsibility, which in self-dispatch markets is allocated to balance responsible parties (BRPs). That is why PSE needs to take care of back up generating reserves for the whole Polish power system, which leads to implementation of allocation constraints if this is necessary to ensure operational security of Polish power system in terms of available generating capacities for upward or downward regulation capacity and residual demand¹⁴. In self-dispatch markets BRPs are themselves supposed to take care about their generating reserves and load following, while TSO ensures them just for dealing with contingencies in the time frame of up to one hour ahead. In a central dispatch market, in order to provide generation and demand balance, the TSO dispatches generating units taking into account their operational constraints, transmission constraints and reserve requirements. This is realized in an integrated scheduling process as an optimization problem called security constrained unit commitment (SCUC) and security constrained economic dispatch (SCED). Thus these two approaches (i.e. self and central dispatch market) ensure similar level of feasibility of transfer capacities offered to the market from the generating capacities point of view.

It was noted above that systemic interpretation of all network codes is necessary to ensure their coherent application. In SO Regulation, the definitions of specific system states involve a role of significant grid users (generating modules and demand facilities). To be in the 'normal' state, a transmission system requires sufficient active and reactive power reserves to make up for occurring contingencies (Article 18) – the possible influence of such issues on cross-zonal trade has been mentioned above. Operational security limits as understood by SO Regulation are also not defined as a closed set, as Article 25 requires each TSO to specify the operational security limits for each element of its transmission system, taking into account at least the following physical characteristics (...). The CACM Regulation definition of contingency (identified and possible or already occurred fault of an element, including not only the transmission system elements, but also significant grid users and distribution network elements if relevant for the transmission system operational security) is therefore consistent with the abovementioned SO Regulation framework, and shows that CACM Regulation application should involve circumstances related to generation and load.

As regards the way PSE procures balancing reserves, it should be noted that the EB Regulation allows TSOs to apply integrated scheduling process in which energy and reserves are procured simultaneously (inherent feature of central dispatch systems). In such a case, ensuring sufficient reserves requires setting a limit to how much electricity can be imported or exported by the system as a whole (explained in more detail below). If CACM Regulation is interpreted as excluding such a solution and mandating that a TSO offers capacity even if it may lead to insufficient reserves, this would make the provisions of EB Regulation void, and make it impossible or at least much more difficult to comply with SO Regulation.

Specification of security limits violated if the allocation constraint is not applied

With regard to constraints used to ensure sufficient operational reserves, if one of interconnected systems suffers from insufficient reserves in case of unexpected outages or unplanned load change (applies to central dispatch systems), there may be a sustained deviation from scheduled exchanges of the TSOs in question. These deviations may lead to an imbalance in the whole synchronous area, causing the system

¹⁴ Residual demand is the part of end users' demand not covered by commercial contracts (generation self-schedules).

frequency to depart from its nominal level. Even if frequency limits are not violated, as a result, deviation activates frequency containment reserves, which will thus not be available for other contingencies, if required as designed. If another contingency materializes, the frequency may in consequence easily go beyond its secure limits with all related negative consequences. This is why such a situation can lead to a breach of operational security limits and must be prevented by keeping necessary reserves within all bidding zones, so that no TSO deviates from its schedule in a sustained way (i.e. more than 15 minutes, within which frequency restoration reserve shall be fully deployed by any given TSO). Finally, the inability to maintain scheduled area balances resulting from insufficient operational reserves will lead to uncontrolled changes in power flows, which may trigger lines overload (i.e. exceeding the thermal limits) and as a consequence can lead to system splitting with different frequencies in each of the subsystems. The above issue affects PSE in a different way from other CCR Hansa TSOs due to reasons explained in the subsequent paragraph.

PSE role in system balancing

PSE directly dispatches all major generating units in Poland taking into account their operational characteristics and transmission constraints in order to cover the load forecasted by PSE, having in mind adequate reserve requirements. To fulfil this task PSE runs the process of operational planning, which begins three years ahead with relevant overhaul (maintenance) coordination and is continued via yearly, monthly and weekly updates to day-ahead SCUD and SCED. The results of this day-ahead market are then updated continuously in intraday time frame up to real time operation.

In a yearly time frame PSE tries to distribute the maintenance overhauls requested by generators along the year in such a way that on average the minimum year ahead generation reserve margin¹⁵ over forecasted demand including already allocated capacities on interconnections is kept on average in each month. The monthly and weekly updates aim to keep a certain reserve margin on each day¹⁶, if possible. This process includes also network maintenance planning, so any constraints coming from the network operation are duly taken into account.

The day-ahead SCUC process aims to achieve a set value of spinning reserve¹⁷ (or quickly activated, in current Polish reality only units in pumped storage plants) margin for each hour of the next day, enabling up and down regulation. This includes primary and secondary control power pre-contracted as an ancillary service. The rest of this reserve comes from usage of balancing bids, which are mandatory to be submitted by all centrally dispatched generating units (in practice all units connected to the transmission network and major ones connected to 110 kV, except Combined Heat and Power (CHP) plants as they operate mainly according to heat demand). The remaining generation is taken into account as scheduled by owners, which having in mind its stable character (CHPs, small thermal and hydro) is a workable solution. The only exception from this rule is wind generation, which due to its volatile character is forecasted by PSE. Thus, PSE has the right to use any available centrally dispatched generation in normal operation to balance the system. The negative reserve requirements during low load periods (night hours) are also respected and the potential pumping operation of pumped storage plants is taken into account, if feasible.

The further updates of SCUC/SCED during the operational day take into account any changes happening in the system (forced outages and any limitations of generating units and network elements, load and wind forecast updates, etc.). It allows to keep one hour ahead spinning reserve at the minimum level of 1000 MW, i.e. potential loss of the largest generating unit, currently 850 MW (subject to change as new units are commissioned) and ca. 150 MW of primary control reserve (frequency containment reserve) being PSE's share in RGCE.

Determination of allocation constraints in Poland

When determining the allocation constraints, the Polish TSO takes into account the most recent information on the aforementioned technical characteristics of generation units, forecasted power system load as well as minimum reserve margins required in the whole Polish power system to ensure secure operation and forward import/export contracts that need to be respected from previous capacity allocation time horizons.

¹⁵ The generation reserve margin is regulated by the Polish grid code and currently set at 18% (point II.4.3.4.18). It is subject to change depending on the results of the development of operational planning processes.

¹⁶ The generation reserve margin for monthly and weekly coordination is also regulated by the Polish grid code (point II.4.3.4.18) and currently set at 17% and 14% respectively.

¹⁷ The set values are respectively: 9% over forecasted demand for up regulation and 500 MW for down regulation. These values are regulated by the Polish grid code (point 4.3.4.19) and subject to change.

Allocation constraints are bidirectional, with independent values for each MTU, and separately for directions of import to Poland and export from Poland.

For each hour, the constraints are calculated according to the below equation:

$$\text{EXPORT}_{constraint} = P_{CD} - (P_{NA} + P_{ER}) + P_{NCD} - (P_L + P_{UPres}) \quad (1)$$

$$\text{IMPORT}_{constraint} = P_L - P_{DOWNres} - P_{CDmin} - P_{NCD} \quad (2)$$

Where:

P_{CD}	Sum of available generating capacities of centrally dispatched units as declared by generators ¹⁸
P_{CDmin}	Sum of technical minima of centrally dispatched generating units in operation
P_{NCD}	Sum of schedules of generating units that are not centrally dispatched, as provided by generators (for wind farms: forecasted by PSE)
P_{NA}	Generation not available due to grid constraints (both planned outage and/or anticipated congestions).
P_{ER}	Generation unavailability's adjustment resulting from issues not declared by generators, forecasted by PSE due to exceptional circumstances (e.g. cooling conditions or prolonged overhauls)
P_L	Demand forecasted by PSE
P_{UPres}	Minimum reserve for up regulation
$P_{DOWNres}$	Minimum reserve for down regulation

For illustrative purposes, the process of practical determination of allocation constraints in the framework of day-ahead transfer capacity calculation is illustrated below: figures 1 and 2. The figures illustrate how a forecast of the Polish power balance for each hour of the next day is developed by TSO day ahead in the morning in order to determine reserves in generating capacities available for potential exports and imports, respectively, for day ahead market. For the intraday market, the same method applies mutatis mutandis.

Allocation constraint in export direction is applicable if ΔExport is lower than the sum of transfer capacities on all Polish interconnections in export direction. Allocation constraint in import direction is applicable if ΔImport is lower than the sum of transfer capacities on all Polish interconnections in import direction.

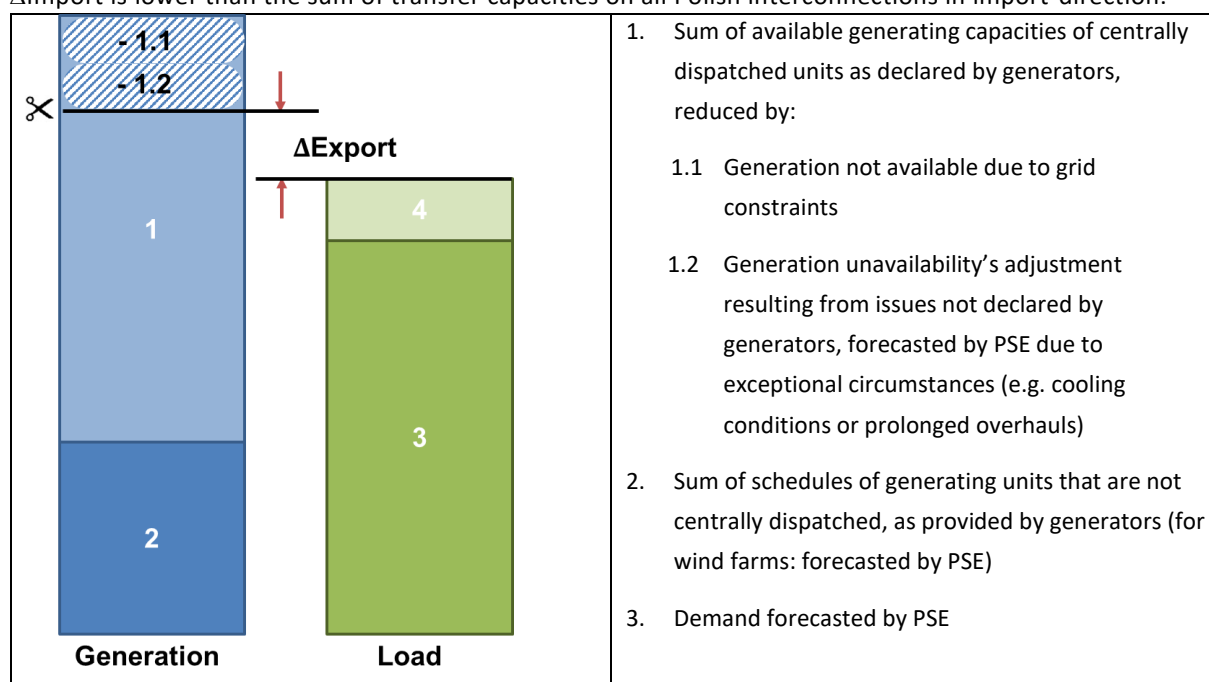

¹⁸ Note that generating units which are kept out of the market on the basis of strategic reserve contracts with the TSO are not taken into account in this calculation.

	4. Minimum necessary reserve for up regulation
--	--

Figure 1: Determination of allocation constraints in export direction (generating capacities available for potential exports) in the framework of day-ahead transfer capacity calculation.

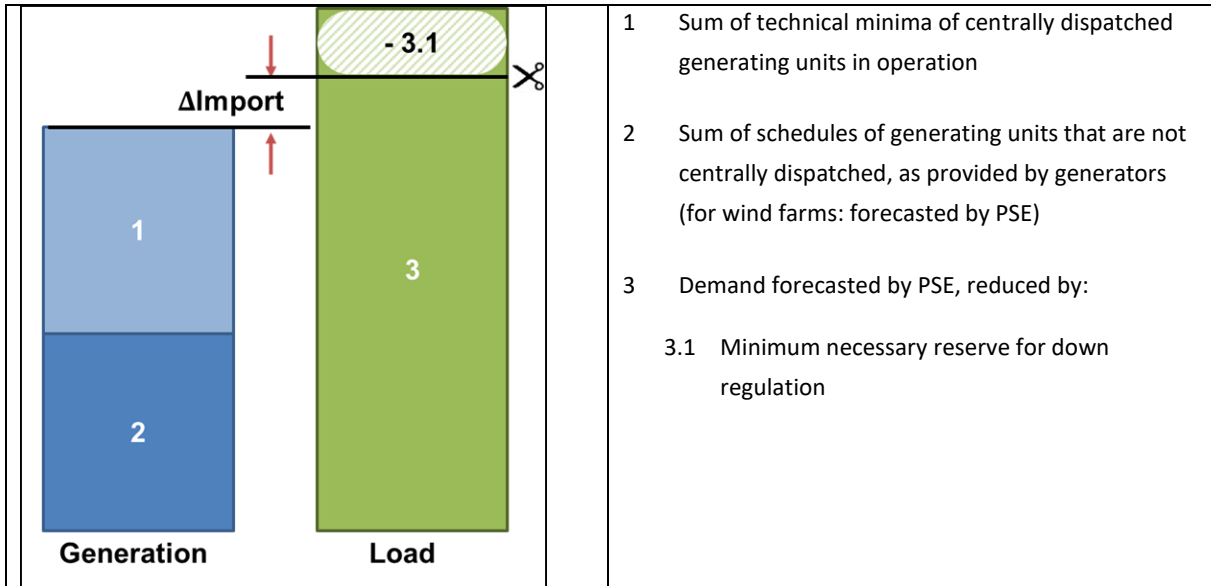

Figure 2: Determination of allocation constraints in import direction (reserves in generating capacities available for potential imports) in the framework of day-ahead transfer capacity calculation.

Frequency of re-assessment

Allocation constraints are determined in a continuous process based on the most recent information, for each capacity allocation time horizon, from forward till day-ahead and intra-day. In case of day-ahead process, these are calculated in the morning of D-1, resulting in independent values for each MTU, and separately for directions of import to Poland and export from Poland.

Impact of allocation constraints on single day-ahead coupling and single intraday coupling

Allocation constraints in form of allocation constraints as applied by PSE do not diminish the efficiency of day-ahead and intraday market coupling process. Given the need to ensure adequate availability of generation and generation reserves within Polish power system by PSE as TSO acting under central-dispatch market model, and the fact that PSE does not purchase operational reserves ahead of market coupling process, imposing constraints on maximum import and export in market coupling process – if necessary – is the most efficient manner of reconciling system security with trading opportunities. This approach results in at least the same level of generating capacities participating in cross border trade as it is the case in self-dispatch systems, where reserves are bought in advance by BRPs or TSO, so they do not participate in cross-border trade, either. Moreover, this allows to avoid competition between the TSO and market participants for generation resources.

It is to be underlined that allocation constraints applied in Poland will not affect the ability of any Hansa country to exchange energy, since these constraints only affect Polish export and/or import. Hence, transit via Poland will be possible in case of allocation constraints applied.

Impact of allocation constraints on adjacent CCRs

Allocation constraints are determined for the whole Polish power system, meaning that they are applicable simultaneously for all CCRs in which PSE has at least one border (i.e. Core, Baltic and Hansa).

It is to be underlined that this solution has been proven as the most efficient application of allocation constraints. Considering allocation constraints separately in each CCR would require PSE to split global allocation constraints into CCR-related sub-values, which would be less efficient than maintaining the global value. Moreover, in the hours when Poland is unable to absorb any more power from outside due to violated

minimal downward generation requirements, or when Poland is unable to export any more power due to insufficient generation reserves in upward direction, Polish transmission infrastructure still can be – and indeed is - offered for transit, increasing thereby trading opportunities and social welfare in all concerned CCRs.

Time periods for which allocation constraints are applied

As described above, allocation constraints are determined in a continuous process for each capacity allocation time frame, so they are applicable for all MTUs (hours) of the respective allocation day.

Why the allocation constraints cannot be efficiently translated into capacities of individual borders offered to the market

Use of capacity allocation constraints aims to ensure economic efficiency of the market coupling mechanism on these interconnectors while meeting the security requirements of electricity supply to customers. If the generation conditions described above were to be reflected in cross-border capacities offered by PSE in form of an appropriate adjustments of border transmission capacities, this would imply that PSE would need to guess the most likely market direction (imports and/or exports on particular interconnectors) and accordingly reduce the cross-zonal capacities in these directions. In the CNTC approach, this would need to be done in a form of ATC reduction per border. However, from the point of view of market participants, due to the inherent uncertainties of market results, such an approach is burdened with the risk of suboptimal splitting of allocation constraints onto individual interconnections – overstated on one interconnection and underestimated on the other, or vice versa. Consequently, application of allocation constraints to tackle the overall Polish balancing constrains at the allocation phase allows for the most efficient use of transmission infrastructure, i.e. fully in line with price differences in individual markets.

Annex 2: Advanced Hybrid Coupling (AHC) – a Short Explanation

Hybrid coupling stands for the combined use of flow-based and Available Transmission Capacity (ATC) constraints in one single allocation mechanism¹⁹, and is found in the shapes of “Standard” and “Advanced”. Though the use of ATC constraints in a flow-based world may not be limited to DC lines only, this explanatory note focuses on this application only, for the sake of clarity.

An ATC constraint sets a limit to a commercial exchange of power between two bidding zones. These ATCs do not physically exist in the grid; indeed, they are the results of scenarios, assumptions, and computations. DC lines between bidding zones are an exception to this statement though: being fully controllable devices, a commercial exchange of 1000 MW between the two bidding zones can be converted directly into a physical flow of exactly 1000 MW on the DC line. In a way, DC lines are the physical reality or representation of an ATC. In short: where an AC grid can be modelled by using the flow-based capacity calculation approach, DC lines interconnecting the AC grids can accurately be modelled by means of ATCs. In order to work in the European market coupling, a hybrid coupling approach is required.

In the next section the interlink between the AC and DC grid is described. Later the difference between Standard and Advanced Hybrid Coupling is explained, followed by a more in-depth description of the capacity calculation and allocation under an Advanced Hybrid Coupling approach.

Interlink between DC connection and AC grid

The power that is traded over the DC link can be produced and consumed anywhere in the AC grid. Therefore, the interaction of the AC grid and the DC grid needs to be modelled.

A DC link is an element, integrated in the AC networks on both sides of the link. Indeed, in the converter stations, where the DC power is transformed into AC power and vice versa, the DC link absorbs its power from, and feeds its power into, the AC grid. From the AC grid point of view, the converter station acts as a source or sink of AC power.

In Figure 11, a DC link is depicted that is interconnecting two AC grids. The white lines represent the AC lines connected to the converter station.

A power flow on the CCR Hansa DC interconnector has a physical impact on the AC grid. If we assume that the power flow on the DC line distributes evenly on the four white AC lines, it implies that 25 % of the flow on the DC line appears as a physical flow on every white AC line.

If during the capacity calculation stage, each of these AC lines has a capacity of 500 MW that can be used by the market, it implies that a maximum DC flow could be allowed of $500 \text{ MW} / 0.25 = 2000 \text{ MW}$.

If we assume the CCR Hansa DC interconnector has a nominal capacity of 1000 MW, it boils down to a maximum physical flow being induced on the AC lines of $1000 \text{ MW} * 0.25 = 250 \text{ MW}$. The remaining 250 MW of capacity can then be used for other market transactions, besides the one on the DC line.

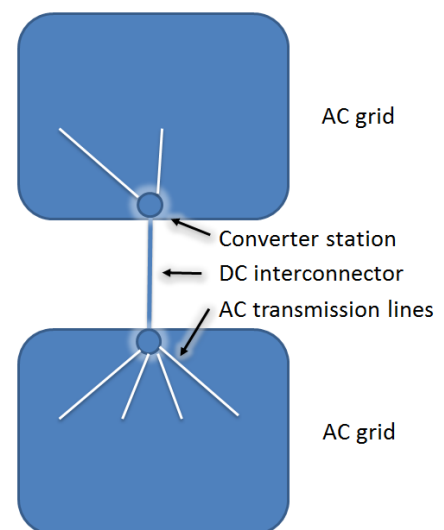

Figure 11: Interlink DC line and AC grid

Hybrid Coupling: Standard and Advanced

As indicated in the introduction, Hybrid Coupling stands for the combined use of flow-based and ATC constraints in one single allocation mechanism. There are two types of hybrid coupling: Standard Hybrid Coupling (SHC) and Advanced Hybrid Coupling (AHC). The difference between those two approaches is highlighted in this section.

Let us consider our example AC transmission line, with a capacity of 500 MW, as introduced above. In a SHC approach, the DC line receives a “priority access” to the AC grid. Simply put: the DC line can transport 1000 MW (it’s full capacity) in both directions, and may use $25\% * \pm 1000 = \pm 250 \text{ MW}$ on the AC transmission line. Under the SHC approach, this capacity is reserved to facilitate the flows on the CCR Hansa DC interconnector and cannot be used by other market

¹⁹ C. Müller, A. Hoffrichter, H. Barrios, A. Schwarz, A. Schnettler: *Integration of HVDC-Links into Flow-Based Market Coupling: Standard Hybrid Market Coupling versus Advanced Hybrid Market Coupling*, CIGRE Symposium Dublin, May/June 2017.

transactions (“what is used by one cannot be used by another”). This is different under the AHC approach, where all capacity on the AC transmission line is available to be shared among the grid users in the most optimal way. This is depicted in Figure 12.

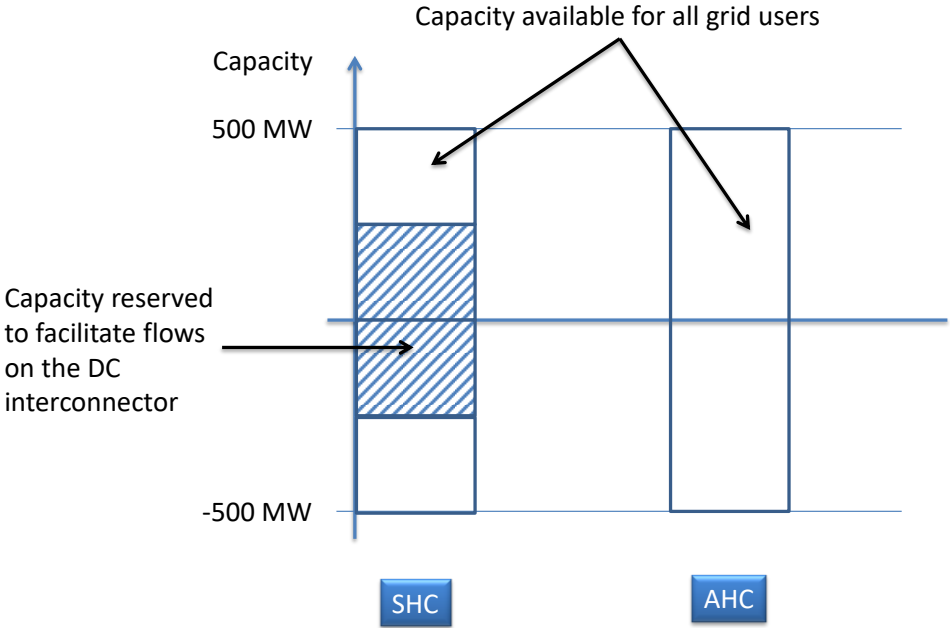

Figure 12: Standard Hybrid Coupling and Advanced Hybrid Coupling

The question how the CCR Hansa DC interconnector is modelled under AHC, and how the capacity on the AC transmission line can be shared among the grid users in the most optimal way is touched upon in the following section.

Capacity calculation and capacity allocation

In the AHC concept, the capacity on the DC line is by default set to its nominal value, which is equal to the full capacity of the DC line²⁰. In our example above, it means that the ATC = 1000 MW for the DC line (assuming the Already Allocated Capacity (AAC) to be zero: AAC = 0).

The impact of the DC line on the AC grid is taken into account in the flow-based capacity calculation of the AC areas. The converter station is treated as a so-called virtual bidding area in the flow-based capacity calculation of the AC area: a bidding zone, without production and consumption. In this way, the impact of having import or export of this virtual bidding area (being a commercial exchange over the DC line) on the critical network elements in the AC grid are properly taken into account.

The example from Figure 11 then translates into the situation depicted in Figure 13. The flow on the CCR Hansa DC interconnector has a one-to-one link to the net position (import/export position) of the virtual bidding area, as demonstrated in Figure 14.

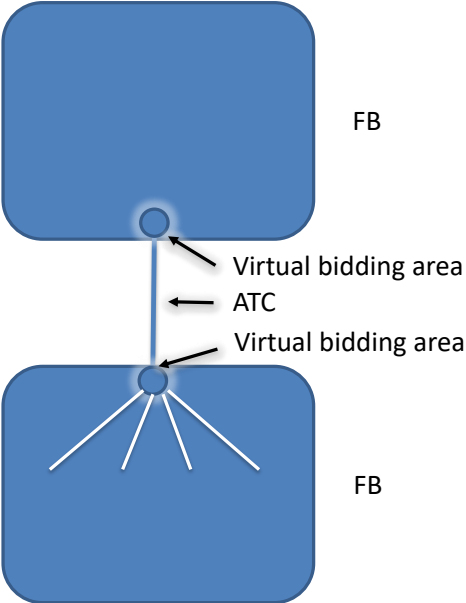

Figure 13: AHC

²⁰ For more details please refer to section 4.2.1

In the example case, the impact of having an export of the virtual bidding area on the critical network element (the AC transmission line that we are focussing on) in the AC grid, amounts to an increase of the line loading of 25 % (and -25 % when the virtual bidding area is in an import position). The so-called power transfer distribution factor (PTDF) in the flow-based methodology equals 0.25. Indeed, the PTDF is a number that translates the amount of export / import to a flow on a critical network element.

In the flow-based methodology, the impact of the virtual bidding area is assessed and quantified in exactly the same way as any other bidding area. Or in other words: when using the AHC, the flow-based methodology specifies the amount of MW available on the different critical network elements, and it determines the amount of MW used when having an import or export from one of the bidding zones and virtual bidding areas. When we zoom in on one of the flow-based areas in Figure 13, we get the image in Figure 15.

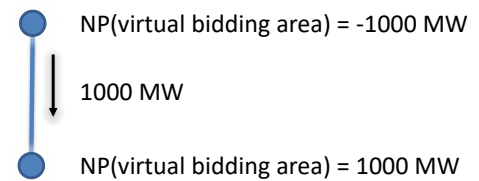

Figure 14: Flow on the DC interconnector and the net position of the virtual bidding area

The flow-based constraint of critical network element 1 (CNE1) in Figure 15, may then look as follows:

$$\alpha * NP(A) + \beta * NP(B) + \gamma * NP(C) + 0.25 * NP(\text{virtual bidding area}) \leq 500 \text{ MW}$$

Where:

- NP: Net position (import or export position of the bidding zone; export being a positive value)
- α, β, γ : PTDF factors, translating the net positions of the bidding zones A, B, and C into expected physical flows on CNE1

Of course, the net position of the virtual bidding area cannot exceed the ATC capacity of the DC line.

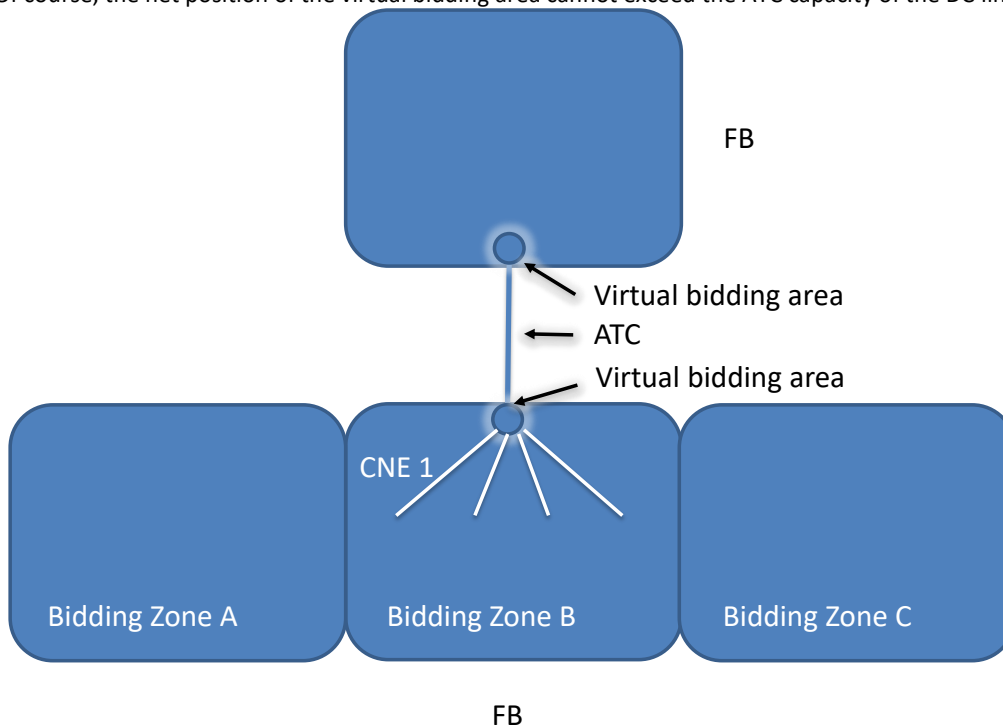

Figure 15: Zoom of the flow-based area

It is the flow-based information from the AC areas and the ATC information from the DC lines that is being provided to the allocation mechanism. It is in the allocation mechanism, where the actual import and export positions (and thereby the exchanges on the DC lines) are determined in the most optimal way given the grid restrictions and the order books.

The allocation – being a European-wide optimisation of the matching of demand and supply, given the grid and allocation constraints – allows all market participants to compete over the scarce resource that is the capacity of a line. This then may result in having a 1000 MW exchange over the DC line, but may also result into an 800 MW exchange

on the DC line if this specific outcome leads to a socio-economic optimum in the overall system. Or in other words: although as a result of the capacity calculation stage, the nominal capacity (1000 MW) on the DC line is provided to the allocation mechanism, the European-wide optimal use of the whole connected transmission grid (given the order books provided) can be a solution where not the full capacity on one specific DC line is utilised in all hours.

AC grid limitations restricting the capacity on the DC line

An exceptional situation may arise in which the surrounding local AC grid, where the converter station is located, is facing some operational challenges due to the power transfer of the DC line. When these challenges cannot be handled by the flow-based methodology, for example when it is related to restrictions located in grids at lower voltage levels or voltage or dynamic issues (that are not modelled in the flow-based system), and the flow on the DC line needs to be limited in order to secure a safe grid operation, the CCR Hansa TSO of that AC grid can impose a constraint in the flow-based methodology to do so.

In this example, the ATC capacity of the DC line will remain 1000 MW. The CCR Hansa TSO facing operational issues, can only allow a maximum flow on the DC line of 750 MW to guarantee the safe operation in the AC grid. He can impose this limit, by adding the following constraint to the virtual bidding area in the flow-based domain:

$NP(\text{virtual bidding area}) \leq 750 \text{ MW}$

With the ATC capacity of the DC line being 1000 MW, and the export position of the virtual bidding area being restricted to a maximum of 750 MW, the net position of the virtual bidding area can be in between -1000 MW and 750 MW.

In this way, it is not for a technical reason linked to the DC line itself, that the capacity is limited (thereby leaving its ATC untouched), but due to operational challenges in the AC grid, and as such expressed in the flow-based capacity constraints from the AC grid.